



**ERIC POLLARD**  
MOUNT BACHELOR, OR  
PESCADO 180 cm

# LINE SKIS

SEASONAL COLLECTION 2016-2017





# DROP IN JOIN IN

For 21 years our door has always been open, welcoming every skier and any idea; never denying or dismissing. This is what has kept us young, fresh and progressive. Our ranks have grown, our gear has expanded and change has been constant in our never ending pursuit of our goal from the beginning, to make skiing more funner.



**ERIC POLLARD**  
 PARKDALE, OR  
 MODEL: PESGADO

**TOM WALLISCH**  
 PARK CITY, UT  
 MODEL: TW PRO

**WILL WESSON**  
 VICTOR, NY  
 MODEL: HONEY BADGER

**LJ STRENIO**  
 BURLINGTON, VT  
 MODEL: CHRONIC

**ANDY PARRY**  
 GOVERNMENT CAMP, OR  
 MODEL: TIGERSNAKE

**ANDREW WHITEFORD**  
 JACKSON HOLE, WY  
 MODEL: SICK DAY 110

# TEAM



**LEO TAILLEFER**  
VAL D'ISÈRE, FR  
MODEL: SUPERNATURAL 115

**SAMI ORTLIEB**  
GLARUS, CH  
MODEL: BLEND

**ROB HEULE**  
CALGARY, AB  
MODEL: BLEND

**COLTER HINCHLIFFE**  
ASPEN, CO  
MODEL: SICK DAY TOURIST

**KIM LANARRE**  
LAC-BEAUPORT, QUEBEC  
MODEL: TOM WALLISCH PRO

**HADLEY HAMMER**  
JACKSON HOLE, WY  
MODEL: PANDORA 110

# PESCADO

**ERIC POLLARD**  
MT BACHELOR, OR  
MODEL: PESCADO

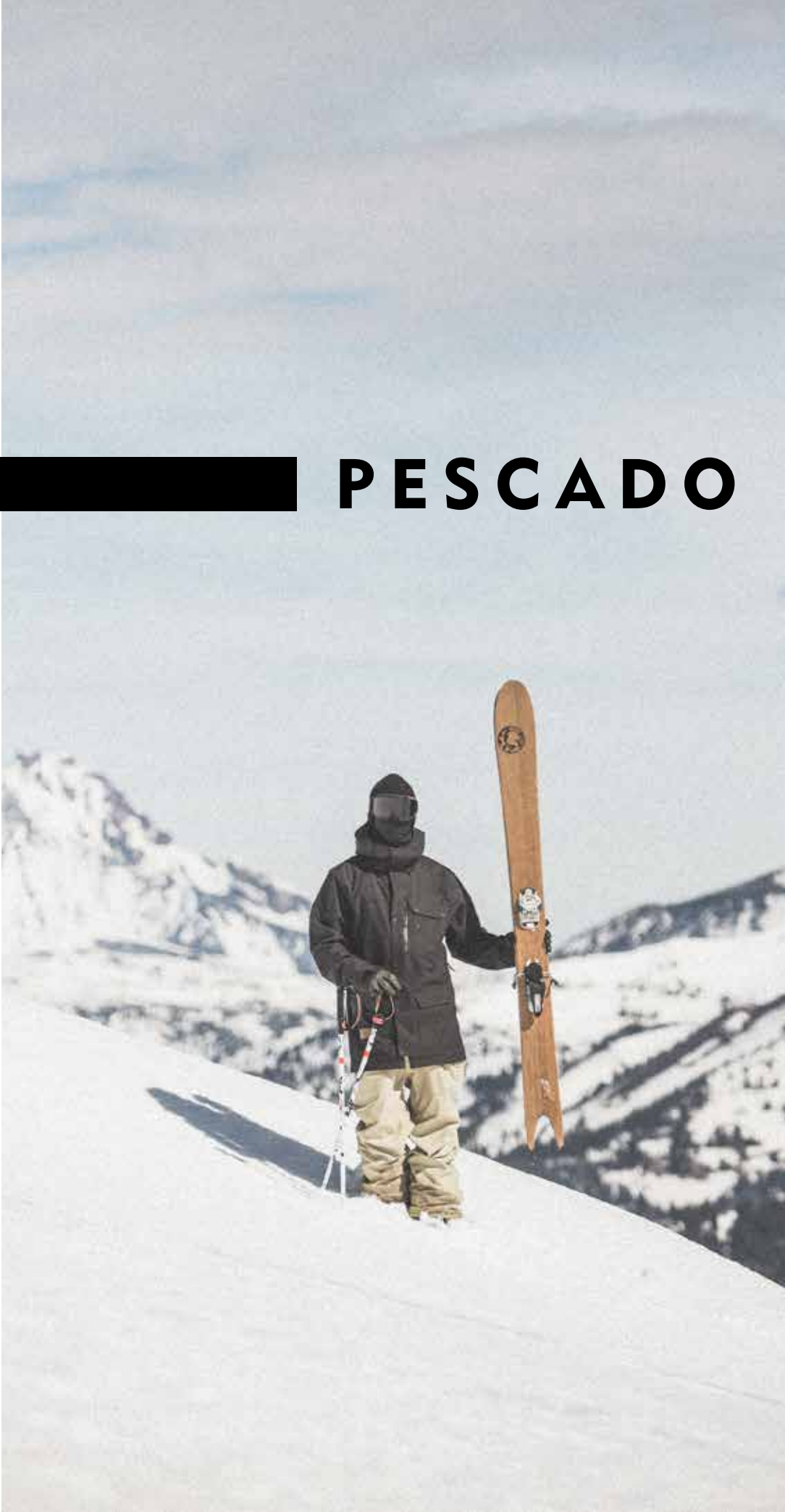









**TOM**

**TOM WALLISCH**  
LINE, HQ  
MODEL: TOM WALLISCH PRO

# MORE FUNNER FREERIDE

NEW & REDESIGNED SUPERNATURAL SKIS

**JEFF CURRY**  
ASPEN, CO  
MODEL: SUPERNATURAL 92





# STREETWEAR

Deliberately dyed materials sewn together for the (fashion forward) backward (or forward) skiing skier. Hoodies, tees and caps ready for personal use. Putting the IT in fit.





## I AM A SKIER

"I am a skier", the saying that's stood the test of time as a symbol of how rad you are. Offered in classic kelly green or something new, this hoodie is a must have for any skier.

**SIZE:** S, M, L, XL

**COLOR:** Kelly Green, Burgundy, Black



## SENDER PULLOVER

The Sender is the most worn hoodie by our team. The Sender's 100% cotton, high collar and simple styling is the go to for skiers on the hill, in the house and around the world.

**SIZE:** S, M, L, XL, TEAM

**COLOR:** Purple



## DROPOUT CREW

It's not about what's on the hoodie, but what's not...and that's a hood. You don't need to couple this with a beanie, cap or cowboy hat this just simply looks good. With full cotton comfort and some sneaky side pockets, this crew gives you function and style you deserve.

**SIZE:** S, M, L, XL

**COLOR:** Heather Grey



## YOGGER SWEATS

Let go yogging! Yogging, the activity of being completely exhausted after a long and fun powder day and the need to be in the most comfortable pants possible no matter if you're in public or on the couch. Yog away amigos, yog all day, everyday.

**SIZE:** S, M, L, XL

**COLOR:** Heather Grey



## SKI FOREVER

**SIZE:** S, M, L, XL

**COLOR:** Kelly Green, Black



## STENCIL

**SIZE:** S, M, L, XL

**COLOR:** Royal, Black



## DROPOUT

**SIZE:** S, M, L, XL

**COLOR:** Light Blue



## POLLARD

**SIZE:** S, M, L, XL

**COLOR:** Dark Grey Heather



## SKIER ONESIE

**SIZE:** 6M, 12M

**COLOR:** Kelly Green



## TODDLER

**SIZE:** 2T, 3T

**COLOR:** Kelly Green



# SKIER BEANIE

SIZE: S, M, L, XL

COLOR: Kelly Green, Black



# SOUL BEANIE

SIZE: S, M, L, XL

COLOR: Safety Yellow, Black



# WORKIN' BEANIE

SIZE: S, M, L, XL

COLOR: Marbled Wool, Safety Orange, Safety Green



# NINJA MASK

SIZE: One size fits all

COLOR: Black



# TOOBY

SIZE: One size fits all

COLOR: Grey



# DROPOUT CAP

SIZE: One size, adjustable

COLOR: Tropical Black



# STENCIL CAP

SIZE: S/M & L/XL

COLOR: Grey



# SUSPENDERS

SIZE: One size fits all

COLOR: Black



# SKATEBOARD

SIZE: 32" x 8"

COLOR: Kelly Green

# FABRIC SACKS

Retooled, re-designed and re-enforced. It's a full on re up of form, function & volume. All the space for your gear in all-new, comfortable & convenient carrying cases.







## REMOTE PACK

Stash & get gone! On the streets or in the mountains the totally redesigned and rebooted Remote Pack has it all. Packed with the necessary and ergonomic features of a ski pack and converts nicely into a stylish burly everyday pack. The Remote comes with an adjustable (or removable) hip belt, interior avy equipment pockets and waterproof zippers.

- Tuck away diagonal ski carry straps
- Hydration sleeve with zippered tube port in shoulder strap
- Stretch mesh side pockets
- Fleece lined goggle/media pocket
- Compression straps
- 600 denier poly ripstop / 900 denier TPU treated poly

**VOLUME:**

25 Liters

**SIZE HxWxD:**

56 x 28 x 22 cm

Insulated shoulder straps  
for hydration

Compression / "A" frame carry

Internal sleeves for shovel  
blade, shaft and probe

Flex mesh side pockets

Diagonal ski carry

Adjustable height and  
removable hip belt

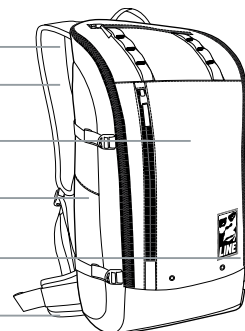



## SLOPE PACK

The best ergonomic pack to drag all your crap from your house to hill just got better! We reinforced key zones, added features to separate the good from the smelly with venting and streamlined our zipper configuration to allow you to change into your boots on the wet ground without stepping in mud.

- Dedicated ski boot puzzle storage
- Large main compartment with big access opening
- Pleated panel that expands for internal helmet storage
- Exterior stretch mesh side pockets
- Front tool pocket
- 600 denier poly ripstop material

**VOLUME:** 40 Liters

**SIZE HxWxD:** 50 x 37 x 26 cm

Integrated boot ventilation

Integrated changing mat

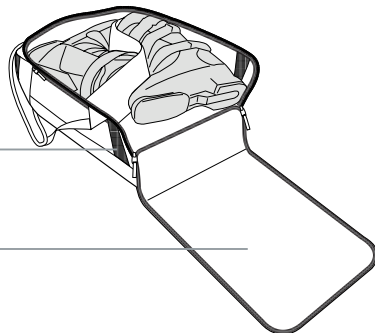

## STREET PACK

The Street Pack has been totally redesigned to rep LINE with style. Students, commuters, and light travelers rejoice.

- Zippered front organizer pocket
- Side gear & bottle pockets
- Top loader with drawstring closure
- Sternum strap
- 600 denier poly ripstop material
- Mesh back panel

**VOLUME:** 22 Liters

**SIZE HxWxD:** 52 x 30 x 20 cm

Top loading lid with cinch top

Internal laptop / tablet sleeve

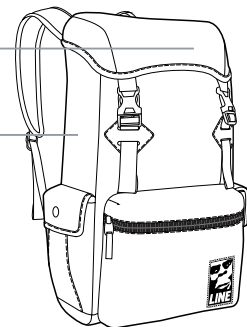



## ROLLER SKI BAG

We heard you! We also heard our athletes, our reps and everyone wanting uncompromisable strength in a roller ski bag. Our engineers went back to the drawing board and reinforced, over stitched and meticulously added features for the skier who wants to bring everything without sacrificing anything.

- Holds 2 pair of 195cm skis with bindings
- Internal cinch straps hold gear in place
- Zipper protecting storm flap!
- Internal large mesh pockets for clothing
- 600 denier poly ripstop material

**VOLUME:** 103L / 6,285 cu. in.

**SIZE HxWxD:** 195 x 36 x 16cm / 76" x 13.75" x 6.3"

All zippers hidden under storm flaps to protect from damage when traveling

Reinforced honeycomb base fore and aft, keeps bag rigid w/ any length skis

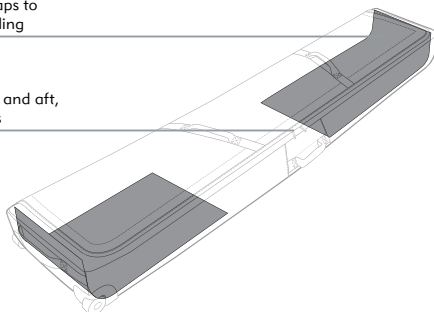

## SKI BAG

Most skiers have that one ski quiver and don't need to bring everything on the plane. This bag is for the skier who's looking to protect their babies while not spending a ton of money. Added stitching on the handles and a padded lining make this burly on a budget.

- Sizes: 165cm & 195cm
- Padded lining
- Hand / Shoulder strap
- Interior tool compartment - Compression straps
- 600 denier poly ripstop material

**VOLUME:** (165cm) 38L / 2,340 cu.in. (195cm) 45L / 2,772 cu.in.

**SIZE HxWxD:** (165cm) 165 x 15 x 15 cm / 65" x 6" x 6"

(195cm) 195 x 15 x 15 cm / 77" x 6" x 6"

Store one pair of skis and or one large snake

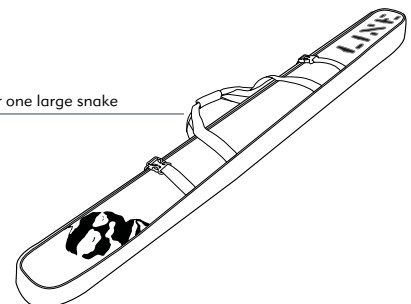

# POINTY STICKS



# POLLARD CARBON

These are Eric Pollard's preferred method of poking powder! Featuring Eric's artwork up top and a machined pattern down below, these adjustable length pointy sticks are perfect for both deep backcountry and in-bounds skiing. EP's Pointy Sticks are light, tight and right for you!

<b>SIZES:</b>	Adjustable 100 -130 cm / 40 - 52 in.
<b>BASKET:</b>	Two Screwoff™ baskets 60mm & 90mm
<b>MATERIAL:</b>	Carbon (Upper) 7075 Aluminum (Lower)
<b>GRIP:</b>	24 dia. Bar Tape grip



**SCREW IT ALL™**  
Screwdriver tip!

## POLLARD'S PAINT BRUSH

The best extendable length stick for all over the mountain! Equipped with a grippier grip and not one, but two sizes of Screwoff!™ baskets. Featuring Screw It All!™ tech which features a pozi-drive screwdriver tip!

<b>SIZES:</b>	Adjustable 100 -130 cm / 40 - 52 in.
<b>BASKET:</b>	Two Screwoff!™ baskets 60mm & 90mm
<b>MATERIAL:</b>	7075 Aluminum
<b>GRIP:</b>	24 dia. Bar Tape grip

## TOM WALLISCHTICK

Wallisch's new pro model pointy stick, Wallisch + Stick=Wallischtick – get it? 9/10 people don't but that's OK! You can be the one that does! This is Tom Wallisch's Pro Model Pointy Stick. Lightweight & durable, these are a great alternative to skiing without sticks in your hands!

<b>SIZES:</b>	90, 95, 100, 105, 115 cm / 36, 38, 40, 42, 44, 46 in.
<b>BASKET:</b>	60mm
<b>MATERIAL:</b>	6061 Aluminum
<b>GRIP:</b>	BMX Rubber



**SCREW IT ALL™**  
Screwdriver tip!



**SCREW IT ALL™**  
Screwdriver tip!

## GRIP STICK

Made of high grade 6061 series aluminum, the Grip Stick features the Snake Grip™, a contoured grip for traditional hand hugs. These are fit for freeride skiing consumption.

<b>SIZES:</b>	100, 105, 110, 115, 120, 125 cm / 40, 42, 44, 46, 48, 50 in.
<b>BASKET:</b>	Two Screwoff™ baskets 60mm & 90mm
<b>MATERIAL:</b>	6061 Aluminum
<b>GRIP:</b>	Snake Grip™ for traditional gripping and grabbing

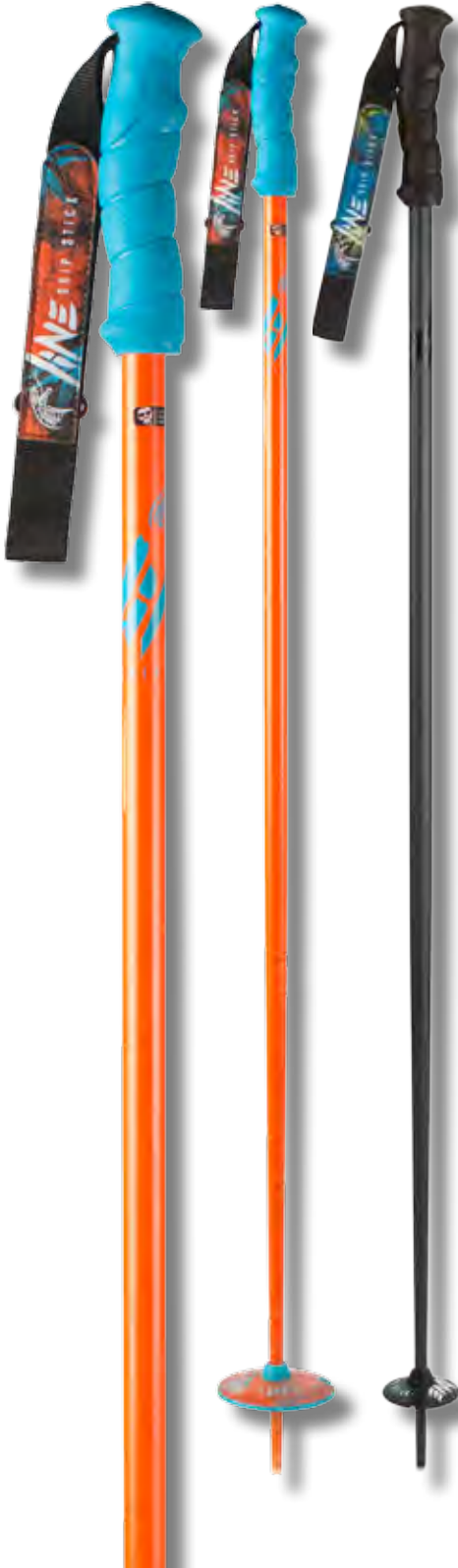

## WHIP

Our crowd favorite returns! The Whip is made of a flexible fiberglass that is made to withstand the ins & outs of g force GS turns! It can bend up to 3x more than aluminum without breaking. You might not make it to après, but this pole will!

<b>SIZES:</b>	100, 105, 110, 115, 120, 125 cm / 40, 42, 44, 46, 48, 50 in.
<b>BASKET:</b>	Two Screwoff™ baskets 60mm & 90mm
<b>MATERIAL:</b>	Fiberglass Construction
<b>GRIP:</b>	26mm dia. Moto rubber grip



## PIN

Everything you need in a pointy stick – lightweight stick in a clean style and a BMX style grip. Our Grab Tabs™ keeps your hand and this pointy stick in a loving relationship.

<b>SIZES:</b>	90, 95, 100, 105, 115 cm / 36, 38, 40, 42, 44, 46 in.
<b>BASKET:</b>	Screwoff™ baskets 60mm
<b>MATERIAL:</b>	6061 Aluminum
<b>GRIP:</b>	25mm dia. BMX rubber grip



## TAC

We said it once and we'll say it again, the TAC is 100% SIMPLE, LIGHT and AFFORDABLE! New this year is the addition of the BMX style grip. No foam, no fill, all thrill!

<b>SIZES:</b>	90, 95, 100, 105, 115 cm / 36, 38, 40, 42, 44, 46 in.
<b>BASKET:</b>	50mm super small basket
<b>MATERIAL:</b>	6061 Aluminum
<b>GRIP:</b>	25mm dia. BMX rubber grip





# HAIRPIN

Designed with the rigorous demands of women in mind. Strong 6061 aluminum and a BMX grip makes the Hairpin the perfect pointy stick accessory for the smarter sex!

<b>SIZES:</b>	90, 95, 100, 105, 115 cm / 36, 38, 40, 42, 44, 46 in.
<b>BASKET:</b>	Screwoff™ baskets 60mm
<b>MATERIAL:</b>	6061 Aluminum
<b>GRIP:</b>	25mm dia. BMX rubber grip



# GETUP

Groms can reach new heights with this adjustable pointy stick that's designed to E-X-P-A-N-D with them as they expand upward!

<b>SIZES:</b>	Adjustable 75 -105 cm / 30 - 42 in.
<b>BASKET:</b>	50mm basket
<b>MATERIAL:</b>	6061 Aluminum
<b>GRIP:</b>	22mm Double Mushroom







# SKI TECH

AARON MATHERS  
LINE HQ  
MODEL: SUPERNATURAL 100



# GEOMETRY

Angles and stuff – Not always sexy but the shapes, rises and tapers are the DNA of the intuitive & consistent feel of a LINE ski.

## EARLY RISE™

The rise of the tip and tail begin earlier as the ski profile moves away from center making for easier turn initiation and helps get the skis up on plane more quickly. This also means effortless float in softer snow!



## LONGER ACTIVE EDGE™

20% more of the sidecut edge length is in contact with the snow when turning which means MORE GRIP & LESS SLIP!



## EARLY TAPER™

The widest point of the sidecut begins tapering earlier in the tip & tail which reduces tail hook ups in powder.



## FIVECUT™

Not one, not two but FIVE different radii shapes are blended into the ski's overall sidecut to give you that intuitive control & unlimited turn shape.

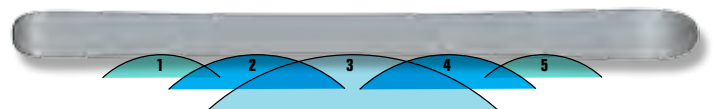



# CONSTRUCTION

Not just pretty on the outside, but also pretty on the inside! These are the guts of the ski that either give it a light & playful personality, stable & precise demeanor or both!

## SHOCKWALL™

80 durometer Elastomer material sandwiched by ABS for vibration and shock absorption resulting in a smooth, solid ride.

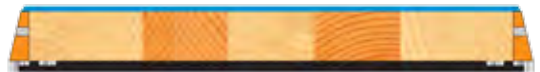

## SIDEWALL

Ultra high density polyethylene walls over the edges absorb vibrations for maximum durability for a smooth, stable feel.



## CAPWALL™

The best of both worlds! Cap on the top for light & playful performance with sidewall over the edge for added precision.



## 4D FIBERCAP™

4 directions of fiberglass are woven across the top of the core for durability without unnecessary weight.



# CORES

Each core construction is chosen to enhance the key attributes of the ski. Whether we're focused on precision and stability or nimbleness and weight, rest assured we've made the best core for the job at hand.

## CLOUD CORE™

Futuristically blended wood and composite materials create an impossibly lightweight and solid core.



## PARTLY CLOUDY CORE™

A blend of light weight wood creating the best strength to weight ratio we offer.



## MAPLE MACROBLOCK

2 full length Maple stringers surrounded by Aspen for increased strength and durability.



## MAPLELITE MACROBLOCK

Solid Maple under foot with lightweight Aspen at the tips for durability and reduced swing weight.



## BAMBOO CORE

A burly core that won't break the bank. Stronger for today's freestyle riding and sustainable fast growing wood makes for an awesome core.



## ASPEN MACROBLOCK

100% Aspen for the lightest, most nimble feel.



# THE MAGIC

It's a bird, it's a plane, no...wait it's the best technological advances in ski design for the last 21 years.

## THIN TIP™

Super thin core & sidewall in the tips are 100 grams lighter per pair for reduced swing weight & tip bounce.



## FATTY BASE & EDGE™

30% thicker base & edge, 2mm wide x 2.5mm high edge and 1.7mm thick base dramatically increases durability and tuning life of these skis.



## DIRECTIONAL FLEX

The softer tip floats & initiates turns easily while the stiffer tail provides power, stability & high speed control.

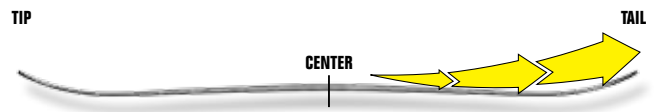

## SYMMETRIC FLEX

The same flex pattern in front and behind your boot conforms to terrain equally riding forward & backwards.

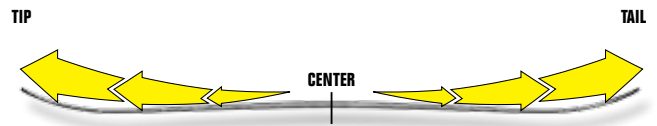

## METAL MATRIX™

Di-cut metal titanal laminate provides more power & grip where you need it while reducing weight where you don't.



## CARBON OLLIEBAND™

Tip to tail carbon-fiber stringers enhance energy & pop to ollie over snowboarders.





# The Shaper

ERIC POLLARD

Eric Pollard is a stalwart in the industry. Chances are if you're reading this, then you too know of his history with Line. But maybe not. Maybe you, reader, are new to both the history of Line Skis and Pollard's indelible mark on skiing as a whole. But where to begin when discussing a skier who's been so intrinsic to the modern day alpine culture, so at the forethought of design - artful & purposeful in his approach to skiing both on and off-piste.

You start with breakfast.

*"While designing my collection of freestyle skis (perfect breakfast burritos), we wanted to make sure we used the lightest, strongest materials*

*(lightest, fluffiest, farm-to-table eggs) in order to assure perfect (delicious) results. With the Pescado much like the Magnum Opus, the design that went into the (omelet) was the culmination of years of hard work with Line and myself" says Pollard in his kitchen. "Both the Mordecai and Sir Francis Bacon are extensions of that drive (hunger) for a better ski - it needs to float thru milky snow, carve the hard-pack and have a buttery personality."*

With decades of collaboration, Pollard has been leading the charge into the unknown of ski shapes, profiles and materials. The new 2017 skis in the Pollard Collection are a feast for the hungry skier.







## PESCADO

/pes.'ka.do/1. A fish that has been caught. This ski is a fish out of water! A directional surfy ski has been in the mind of EP for years. With bamboo sidewalls, Partly Cloudy™, a veneer topsheet with a timeless graphic, the Pescado fuses the best of surfing, art and skiing.



<b>LENGTHS:</b>	180	<b>CORE:</b>	Partly Cloudy™
<b>SHAPE mm:</b>	158-125-147	<b>BASE:</b>	Sintered
<b>WEIGHT/ PAIR(g):</b>	3,900	<b>FLEX:</b>	Directional Flex™
<b>SIDECUT AVG. m:</b>	19	<b>GEOMETRY:</b>	5-Cut™
<b>STANCE mm:</b>	-80 (Eric's choice)	<b>CONSTRUCTION:</b>	Sidewall
<b>PROFILE mm:</b>	20-4-1	<b>EDGE mm:</b>	1.7 x 2



## MAGNUM OPUS

Rising above all freestyle powder skis with an award-winning intuitive edge to edge feel, the Magnum is a playful, yet stable ski with Eric Pollard's stamp of approval. The new Bamboo sidewalls add more durability for flying into battle with any terrain.



<b>LENGTHS:</b>	188	<b>CORE:</b>	Cloud Core™
<b>SHAPE mm:</b>	148-124-146	<b>BASE:</b>	Sintered
<b>WEIGHT/ PAIR(g):</b>	3,900	<b>FLEX:</b>	Symmetric Flex™
<b>SIDECUT AVG. m:</b>	17	<b>GEOMETRY:</b>	5-Cut™
<b>STANCE mm:</b>	-20 (Eric's choice)	<b>CONSTRUCTION:</b>	Sidewall
<b>PROFILE mm:</b>	12-3-12	<b>EDGE mm:</b>	1.7 x 2



## MORDECAI

There's no better platform for a nimble and playful all over the mountain powder ski. Slash it! Butter it! Smear it! This is your tool for all manners of mountain mayhem.



<b>LENGTHS:</b>	179, 186, 193	<b>CORE:</b>	Partly Cloudy™
<b>SHAPE mm:</b>	141-114-138	<b>BASE:</b>	Sintered
<b>WEIGHT/ PAIR(g):</b>	4,058	<b>FLEX:</b>	Symmetric Flex™
<b>SIDECUT AVG. m:</b>	17	<b>GEOMETRY:</b>	5-Cut™
<b>STANCE mm:</b>	-21 (Eric's choice)	<b>CONSTRUCTION:</b>	Sidewall
<b>PROFILE mm:</b>	15-5-15	<b>EDGE mm:</b>	1.7 x 2



## SIR FRANCIS BACON

Refined, redefined but never failing to deliver a true all mountain freestyle approach in this award-winning ski. Less weight, more stability in a sleek profile. The Bacon goes great with everything.



<b>LENGTHS:</b>	178, 184, 190	<b>CORE:</b>	Partly Cloudy™
<b>SHAPE mm:</b>	135-104-131	<b>BASE:</b>	Sintered
<b>WEIGHT/ PAIR(g):</b>	4,090	<b>FLEX:</b>	Symmetric Flex™
<b>SIDECUT AVG. m:</b>	17.4	<b>GEOMETRY:</b>	5-Cut™
<b>STANCE mm:</b>	-21 (Eric's choice)	<b>CONSTRUCTION:</b>	Sidewall
<b>PROFILE mm:</b>	9-3-9	<b>EDGE mm:</b>	1.7 x 2

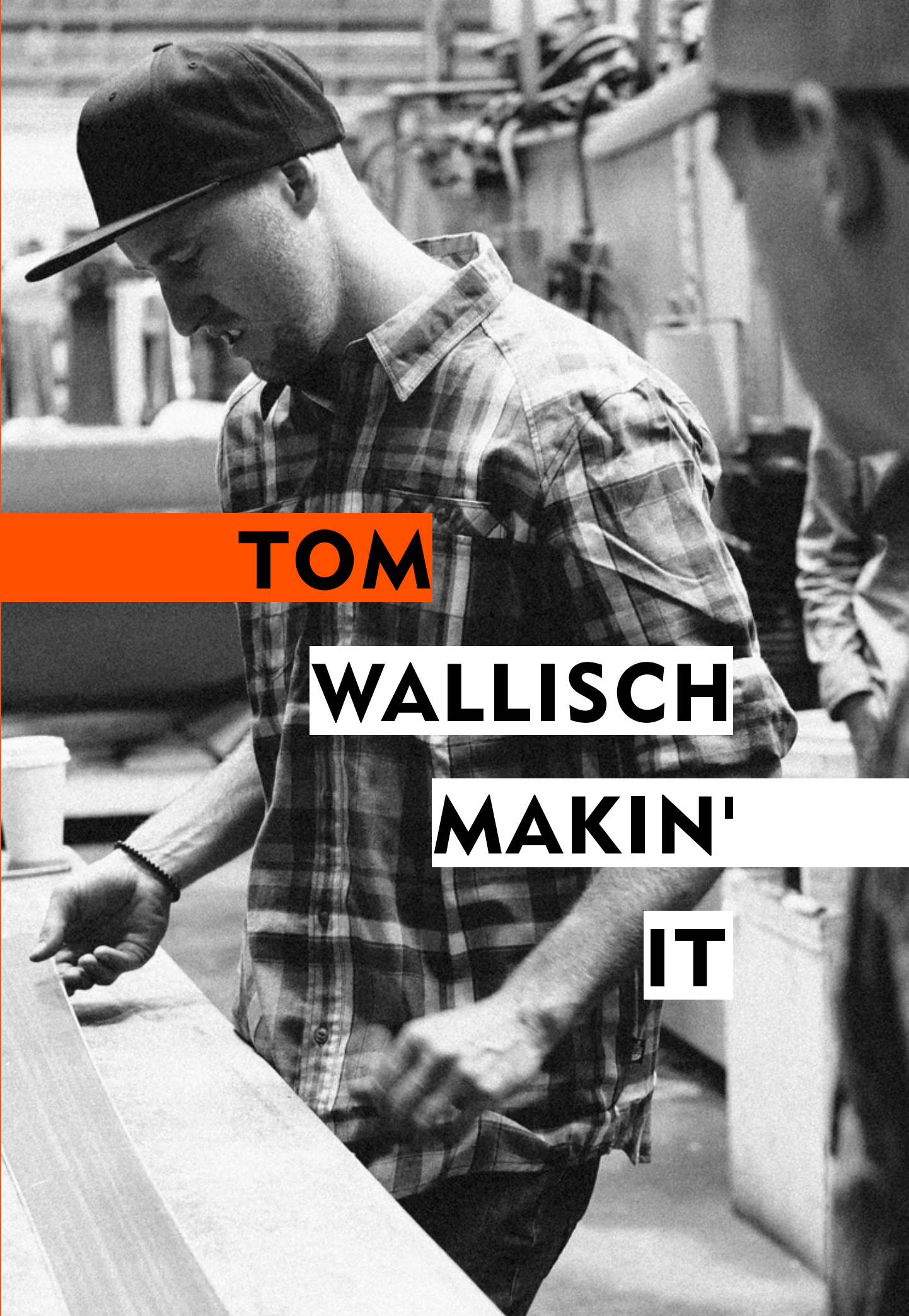

**TOM**

**WALLISCH**

**MAKIN'**

**IT**

**P**ittsburgh, PA native, Tom Wallisch is a skiing superstar from unlikely origins. His comfort on skis has always been impressive despite having grown up skiing some of the smaller resorts on the East Coast of U.S. like Seven Springs and WISP. Tom burst on to the freeski scene with his mind-bending SuperUnknown edit (Google it), his transformation from “SuperUnknown” to a household name took just a couple of years, revolutionizing skiing in the process. Tom’s banger segments in films from the likes

## HE TRULY IS THE SKIER'S SKIER

of Level 1, Field Productions and 4bi9 appeared year after year. Despite a rigorous filming schedule, Wallisch managed to top the field at nearly every major competition. His '11-'12 season was the most impressive where he topped the podium at the Killington, VT and Breckenridge, CO stops of the Dew Tour and also winning the Winter X Games in Aspen, CO.

His momentum continues as Wallisch remains the biggest name in freestyle skiing and is the most viewed athlete on Newschoolers.com, attracting fans from all across the freeskiing spectrum for his effortless backcountry booters and 30' closeout rails. His style is the standard by which all others are now measured. Despite the fame, Tom is constantly smiling, stoked and approachable, and always makes time to hang out with fans. He truly is a skier's skier.

Most recently, Wallisch co-founded The Good Company, a new film crew with long time friend and collaborator Kyle Decker. He signed with Line Skis, where he's been developing his new pro model – a process Brand Director Josh Malczyk describes as “a most excellent adventure,” adding that, true to character, “Tom’s feedback, insight and general passion for being able to make gear he’s proud of, motivates everyone in the company”. As he enters his 10th year in the ski industry spotlight, Wallisch is going from strength to strength. His every move is prone to break the internet and continue to push skiing in the right direction.

X

BY ADAM "TWIG" SPENSLEY  
NEWSCHOOLERS EDITOR



## TOM WALLISCH PRO

This is Tom Wallisch's ski. It goes anywhere Tom does. On chairlifts. On trails. On rails. Off jumps. On airplanes. On podiums. On quad kinks. On wall rides. On car rides. On...you get the point. This is a stable ski for jumping on and off things. A Carbon Ollieband™ adds even more pop!



<b>LENGTHS:</b>	164, 171, 178	<b>CORE:</b>	Maple Macroblock
<b>SHAPE mm:</b>	117-90-112	<b>BASE:</b>	Sintered
<b>WEIGHT/ PAIR(g):</b>	3,324	<b>FLEX:</b>	Symmetric Flex™
<b>SIDECUT AVG. m:</b>	18.3	<b>GEOMETRY:</b>	5-Cut™
<b>STANCE mm:</b>	-30 (Tom's choice)	<b>CONSTRUCTION:</b>	Capwall
<b>PROFILE mm:</b>	12-3-12	<b>EDGE mm:</b>	Fatty 2.2 x 2.5

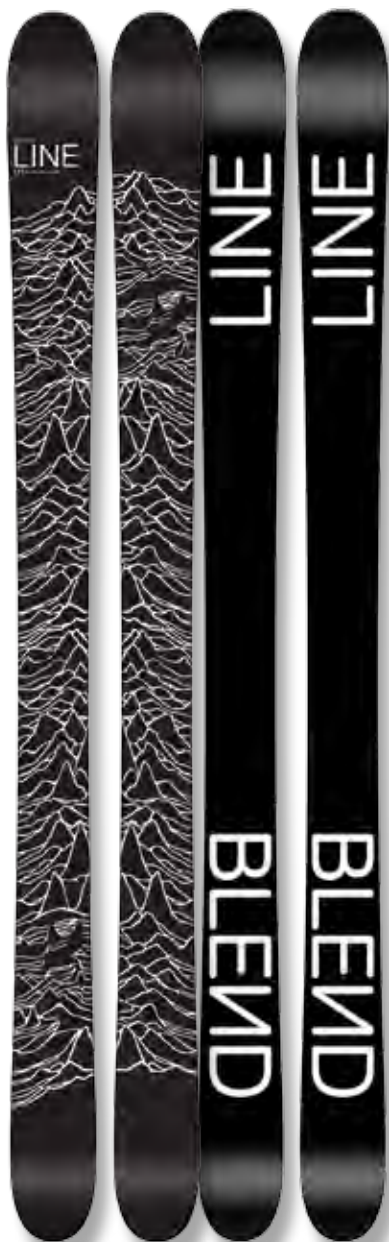

## BLEND

The best mix of personalities without the emotional baggage! Backcountry to park and back, the Blend is your all-in-one tool to slay mid winter pow or send 'er through spring park laps.



<b>LENGTHS:</b>	171, 178, 185	<b>CORE:</b>	Maple Macroblock
<b>SHAPE mm:</b>	132-100-122	<b>BASE:</b>	Sintered Fatty
<b>WEIGHT/ PAIR(g):</b>	3,870	<b>FLEX:</b>	Symmetric Flex™
<b>SIDECUT AVG. m:</b>	20.5	<b>GEOMETRY:</b>	5-Cut™
<b>STANCE mm:</b>	-40	<b>CONSTRUCTION:</b>	Capwall
<b>PROFILE mm:</b>	4-4-4	<b>EDGE mm:</b>	Fatty 2.2 x 2.5



## CHRONIC

Don't even bother reading this. You should know by now that the Chronic is the original freestyle park ski designed to be bombproof – ready & up for anything you're ready to throw at it.



<b>LENGTHS:</b>	164, 171, 178, 185	<b>CORE:</b>	Maple Macroblock
<b>SHAPE mm:</b>	121-92-117	<b>BASE:</b>	Sintered Fatty
<b>WEIGHT/ PAIR(g):</b>	3,596.4	<b>FLEX:</b>	Symmetric Flex™
<b>SIDECUT AVG. m:</b>	17.5	<b>GEOMETRY:</b>	5-Cut™
<b>STANCE mm:</b>	-40	<b>CONSTRUCTION:</b>	Sidewall
<b>PROFILE mm:</b>	2.5-2	<b>EDGE mm:</b>	Fatty 2.2 x 2.5

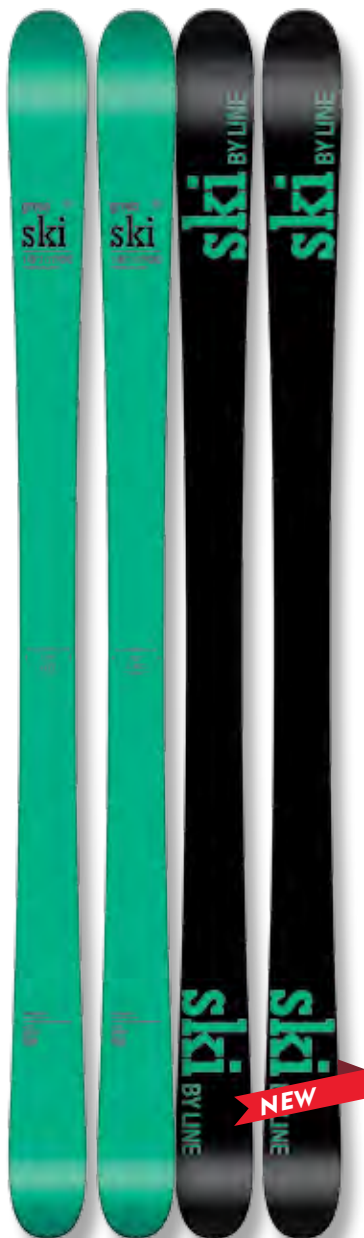

## HONEY BADGER

The all-new Honey Badger is...well, it don't give a sh\*t. Made to be tough as nails, given a simple design, a bomber bamboo core and an affordable price – this little package has the bite it needs to kick ass in the park, streets and entire mountain. The Honey Badger.



<b>LENGTHS:</b>	155, 166, 172, 177	<b>CORE:</b>	Bamboo
<b>SHAPE mm:</b>	120-92-116	<b>BASE:</b>	Extruded Fatty
<b>WEIGHT/ PAIR(g):</b>	3,020	<b>FLEX:</b>	Symmetric Flex™
<b>SIDECUT AVG. m:</b>	18	<b>GEOMETRY:</b>	5-Cut™
<b>STANCE mm:</b>	-30	<b>CONSTRUCTION:</b>	4D Fibercap
<b>PROFILE mm:</b>	3-3-3	<b>EDGE mm:</b>	Fatty 2.2 x 2.5



## TIGERSNAKE

The Tigersnake is your ticket to getting onto the hill, into the park & all over the mountain. This is the most tech-filled, affordable and lightest all terrain freestyle ski on the market! A Carbon Ollieband™ adds even more pop!



<b>LENGTHS:</b>	157, 164, 171, 178	<b>CORE:</b>	Aspen
<b>SHAPE mm:</b>	113-88-109	<b>BASE:</b>	Extruded Fatty
<b>WEIGHT/ PAIR(g):</b>	3,020	<b>FLEX:</b>	Symmetric Flex™
<b>SIDECUT AVG. m:</b>	17.6	<b>GEOMETRY:</b>	5-Cut™
<b>STANCE mm:</b>	-23	<b>CONSTRUCTION:</b>	4D Fibercap
<b>PROFILE mm:</b>	12-3-12	<b>EDGE mm:</b>	Fatty 2.2 x 2.5

**RIGHT**

**COAST**

**RIPPING**

BY  
JEFF CURRY





---

28 year old Jeff Curry from Pittsfield, MA USA has transitioned from east coast park skier to all-mountain ripper in his 15 plus years of riding LINE.

---

**G**rowing up skiing on the East Coast in the early 90's has shaped me into the skier I am today. Learning how to ski on the East has its many disadvantages but it's the struggle that builds strong skiers.

When I first started out skiing, I fell in love with the speed and adrenaline rush from blazing down the hill. By the time I had reached high school, freeskiing had started to take off and I found myself on a constant search for air, and new tricks, taking hold of my life for the next 15 years. I became obsessed with learning how to do the next big trick and tailoring my own style to those tricks.

## RIP AROUND THE HILL

I have always considered myself a skier, not just a freestyle skier, and this past season I began a mission to get back to my roots. After abusing my body in the park year after year, I couldn't help but start to feel the cumulative effect, not to mention four major surgeries throughout the years.

As I get older and transition away from the park, I have found a need for a directional ski that has the same bad ass capabilities as some of my favorite park skis, a ski that can still give you that adrenaline rush that matches hitting a 100 foot jump. I've moved from focusing on going higher and doing more spins to going deeper into the backcountry and finding steeper, more challenging terrain.

Today my daily drivers are freeride-based directional skis. Having a ski that can rip around the hill became more important than doing park tricks. Getting back on a directional ski has brought me back to the feeling that made me first fall in love with skiing.

Skiing has always been fun, and for me it just took the right ski to remind me how much fun I was having outside the park.

---



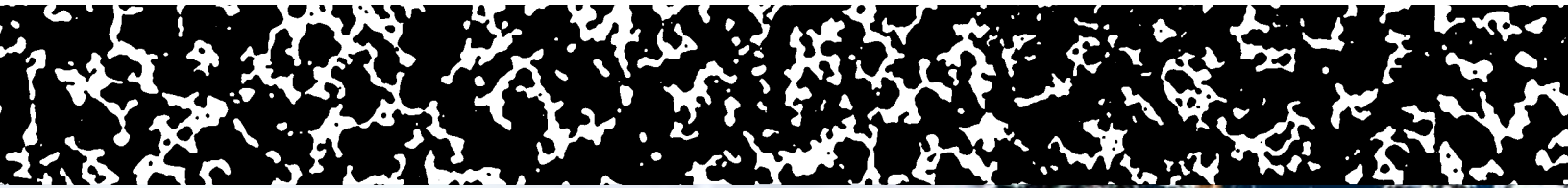

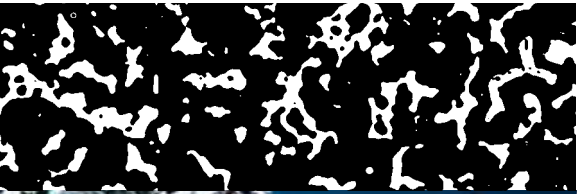

# SICK DAY

JEFF CURRY  
ASPEN, CO  
MODEL: SICK DAY 110



# TRIP REPORT

Every spring, I try and hold onto skiing as long as possible. I've even made it into a campaign, of sorts: #NotOverIt. I like to imagine I started that hashtag. This spring was no different. Or maybe it was. It was epic. The Elk Range, my home base, stayed white and snowy well into June and my friends and I made sure to get after it. I skied many lines I had skied before and a few I hadn't. One of those new lines turned out to be a first decent of the direct North face of Capitol Peak.

Capitol Peak, which stands at 14,130 feet, is the Holy Grail of all the mountains in Colorado. There's no easy way up. There's certainly no easy way down. I've actually skied Capitol in the past. A few years prior, I had skied another epic first descent which was my motivation this time around. I wanted to repeat that previous line but as I began looking into the route with my partners, we noticed something else — a new opportunity. With all the late snow, a much more direct

line was possible. Or so we thought.

With some fairly serious recon, we formed a plan and pulled the trigger with a party of three. Our day started at midnight. We made our approach under a full moon and though I had done my best to sleep during the day before, I wasn't rested. You know how that shit goes.

## AND THEN IT GOT SPOOKY.

Exhausted, we pushed for it. Watching a full moon touch the western horizon as the sun peeked in the east, we gained our final summit ridge. We hit the summit at 9 a.m., and then it got spooky.

At just over 14,000 feet, Capitol sapped our confidence. The top portion of the face was not an option any of us wanted to ski, partly because it looked like sure death. Going back down the way we came was not promising either;

it was facing east, getting hot and getting dangerous. Amid thin air, we made the decision to drop in on the planned line, albeit on a rope rather than skis. Two pucker-inducing rappels later and we were in the heart of our line, enjoying some heads up skiing. We put the ropes over our packs for 2000' until we arrived at a massive cliff. After two more sketchy rappels supported with pickets and cams, we arrived on a low angle apron beneath the cliff face. We had survived three hours in a place not suitable to human life and got some special turns while we were there. When we got to the car, we celebrated with a beer and cheeseburger on the grill. It's these adventures I live for. Because of these adventures I'm for sure #NotOverIt.

BY COLTER HINCHLIFFE



## SICK DAY TOURIST

Get up! Get down! This ski ascends and descends with you! Grab your passport and strap on your fanny pack and head to the BC. This ski is the perfect blend of durability & float wrapped up in the award winning chassis. The Tourist is your gateway to the backcountry.



<b>LENGTHS:</b>	179, 186	<b>CORE:</b>	Cloud Core™
<b>SHAPE mm:</b>	135-102-120	<b>BASE:</b>	Sintered
<b>WEIGHT/ PAIR(g):</b>	3,120	<b>FLEX:</b>	Directional Flex™
<b>SIDECUT AVG. m:</b>	18.7	<b>GEOMETRY:</b>	5-Cut™
<b>STANCE mm:</b>	-75	<b>CONSTRUCTION:</b>	Shockwall
<b>PROFILE mm:</b>	8-4-3	<b>EDGE mm:</b>	1.7 x 2



## SNAKE SKINS

Slither your way up the skin track in no time and shed them when you're ready to attack! Constructed by world leader Pomoca™ in Switzerland, these climbing skins are built to last with a look that will stand out from the rest.

<b>LENGTHS:</b>	Small 165-175 cm, Medium 175-185 cm, Large 185-195 cm
<b>WIDTH mm:</b>	140



# SICKENINGLY AWESOMELY AWARDED!

In just the first 3 years of existence, the Sick Day Series is one of the most awarded ski shapes in the world! From narrow to wide, the lightweight directional freeride ski has turned the heads of the world's media and turned on even more skiers to LINE.

**TIME TO CALL IN A SICK DAY AND GO SHRED!**



## SICK DAY 110

The crowd favorite to conquer the slack country, backcountry and hard pack, the 110 is your choice. Hell, it'll even conquers après! From opening bell to last call, this ski's for you!



<b>LENGTHS:</b>	172, 179, 186	<b>CORE:</b>	Maple Lite
<b>SHAPE mm:</b>	142-110-125	<b>BASE:</b>	Sintered
<b>WEIGHT/ PAIR(g):</b>	4,014	<b>FLEX:</b>	Directional Flex™
<b>SIDECUT AVG. m:</b>	18.1	<b>GEOMETRY:</b>	5-Cut™
<b>STANCE mm:</b>	-75	<b>CONSTRUCTION:</b>	Capwall
<b>PROFILE mm:</b>	10-5-5	<b>EDGE mm:</b>	2.1 x 2



## SICK DAY 102

The 102 is your perfect excuse for ditching your morning meeting and the perfect mix of 95 & 110 waist widths. Catch first tracks in the AM and send it on the hardpack in the PM. TPS reports can wait.



<b>LENGTHS:</b>	172, 179, 186	<b>CORE:</b>	Maple Lite
<b>SHAPE mm:</b>	148-124-146	<b>BASE:</b>	Sintered
<b>WEIGHT/ PAIR(g):</b>	3,800	<b>FLEX:</b>	Directional Flex™
<b>SIDECUT AVG. m:</b>	17.1	<b>GEOMETRY:</b>	5-Cut™
<b>STANCE mm:</b>	-75	<b>CONSTRUCTION:</b>	Capwall
<b>PROFILE mm:</b>	8-4-3	<b>EDGE mm:</b>	2.1 x 2



## SICK DAY 95

Get ahead of the masses on the Sick Day 95! This ski is perfect for floating through much of anything the mountain tosses at you without ever sacrificing the hold on hardpack.



<b>LENGTHS:</b>	172, 179, 186	<b>CORE:</b>	Maple Lite
<b>SHAPE mm:</b>	130-95-115	<b>BASE:</b>	Sintered
<b>WEIGHT/ PAIR(g):</b>	3,704	<b>FLEX:</b>	Directional Flex™
<b>SIDECUT AVG. m:</b>	18.2	<b>GEOMETRY:</b>	5-Cut™
<b>STANCE mm:</b>	-70	<b>CONSTRUCTION:</b>	Capwall
<b>PROFILE mm:</b>	7-5-5	<b>EDGE mm:</b>	2.1 x 2

# ■ SUPERNATURAL SERIES

JEFF CURRY  
ASPEN, CO  
MODEL: SUPERNATURAL 108







## SUPERNATURAL 115

This powder ski will graciously gobble up everything Mother Nature has to offer and then come back asking for seconds! Carbon stringers give back the energy you put into the ski, turn it up to 11 and go!



<b>LENGTHS:</b>	179, 186, 192	<b>CORE:</b>	Maple Macroblock
<b>SHAPE mm:</b>	145-115-131	<b>BASE:</b>	Sintered
<b>WEIGHT/ PAIR(g):</b>	4,940	<b>FLEX:</b>	Directional Flex™
<b>SIDECUT AVG. m:</b>	21	<b>GEOMETRY:</b>	5-Cut™
<b>STANCE mm:</b>	-80.5	<b>CONSTRUCTION:</b>	Capwall
<b>PROFILE mm:</b>	10-4.5-8	<b>EDGE mm:</b>	Fatty 2.2 x 2.5

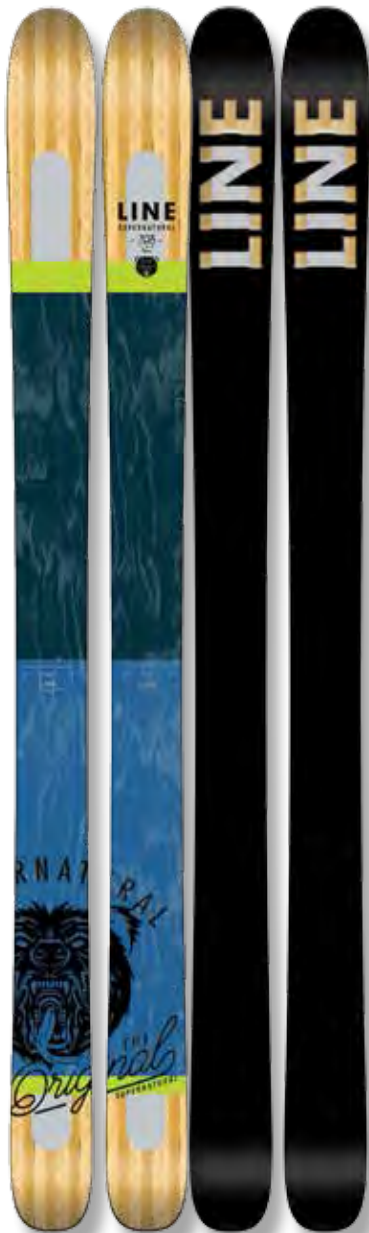

## SUPERNATURAL 108

A fantastic balance of the float & stability of wider width skis featured on a 108mm chassis that will let you ski start to finish in all conditions!



<b>LENGTHS:</b>	179, 186, 192	<b>CORE:</b>	Maple Macroblock
<b>SHAPE mm:</b>	137-108-126	<b>BASE:</b>	Sintered
<b>WEIGHT/ PAIR(g):</b>	4,282	<b>FLEX:</b>	Directional Flex™
<b>SIDECUT AVG. m:</b>	22.3	<b>GEOMETRY:</b>	5-Cut™
<b>STANCE mm:</b>	-76	<b>CONSTRUCTION:</b>	Shockwall
<b>PROFILE mm:</b>	12-3-6	<b>EDGE mm:</b>	2.1 x 2



## SUPERNATURAL 100

Engineered to fit 200% on-hill enjoyment into 100mm of intuitive turn shape and a stable flex pattern. Cut thru the crud & crowds on the Supernatural 100!



<b>LENGTHS:</b>	179, 186, 192	<b>CORE:</b>	Maple Macroblock
<b>SHAPE mm:</b>	132-100-121	<b>BASE:</b>	Sintered
<b>WEIGHT/ PAIR(g):</b>	4,136	<b>FLEX:</b>	Directional Flex™
<b>SIDECUT AVG. m:</b>	21.3	<b>GEOMETRY:</b>	5-Cut™
<b>STANCE mm:</b>	-76.5	<b>CONSTRUCTION:</b>	Shockwall
<b>PROFILE mm:</b>	5-4-3	<b>EDGE mm:</b>	2.1 x 2



REDESIGNED

## SUPERNATURAL 92

The Re-designed 92 is the best medium width ski to handle all those hardpack pucker moments and more! Newly shaped for easier turning and initiation that gives it a little more give on the edge-to-edge without talking back.



<b>LENGTHS:</b>	165, 172, 179, 186	<b>CORE:</b>	Maple Macroblock
<b>SHAPE mm:</b>	131-92-118	<b>BASE:</b>	Sintered
<b>WEIGHT/ PAIR(g):</b>	3,908	<b>FLEX:</b>	Directional Flex™
<b>SIDECUT AVG. m:</b>	19.6	<b>GEOMETRY:</b>	5-Cut™
<b>STANCE mm:</b>	-79	<b>CONSTRUCTION:</b>	Sidewall
<b>PROFILE mm:</b>	4-4-1	<b>EDGE mm:</b>	2.1 x 2



NEW

## SUPERNATURAL 86

New! All the best qualities of the Supernatural wrapped up in a slimmer width for a more approachable feel on-piste. An awesome option for hard-charging through crud on the frontside.



<b>LENGTHS:</b>	165, 172, 179	<b>CORE:</b>	Maple Macroblock
<b>SHAPE mm:</b>	125-86-112	<b>BASE:</b>	Sintered
<b>WEIGHT/ PAIR(g):</b>	3,972	<b>FLEX:</b>	Directional Flex™
<b>SIDECUT AVG. m:</b>	17.8	<b>GEOMETRY:</b>	5-Cut™
<b>STANCE mm:</b>	-75.5	<b>CONSTRUCTION:</b>	Sidewall
<b>PROFILE mm:</b>	3-4-1	<b>EDGE mm:</b>	2.1 x 2



P. Jonathan Selkowitz



# WOMEN'S

HADLEY HAMMER  
PORTILLO, CHILE  
MODEL: PANDORA 110



# ▶ THE LOVE OF ████████████████████ SKIING

**I** have had a lot of great days skiing. My first run in Alaska. My first time competing in Europe. My first time sliding a rail. But for some reason, the day that always seems to stand above them all is a powder day when I was in high school.

This wasn't your standard, "run-of-the-mill" powder day – waiting in the Jackson tram line or looking for the largest air or seeking untracked stashes. No. This was a powder day where I was peeing my pants with laughter as I watched my best friend Emily soar through the air, about every six turns. I'd given Emily a pair of skis, and in typical high school forgetfulness, we didn't adjust the bindings. Having a binding issue is usually a day wrecker. For us, it was a day maker.

I can't remember a four hour

period in my life where I've laughed harder (and yes I did just watch Pitch Perfect 2 twice in a row on an international flight). The soft snow cushioned every one of her spectacular crashes. The ejections, while consistent, were random in their timing and results. Sometimes just one ski would come off, other times she would take more air than Michael Jordan. Many times we thought of running into the ski shop to have her bindings adjusted. But in the end, it was just simply more fun for her to double eject and me to watch.

And that's why I love skiing. Because you never know when you're going to have the best day. It could be a blue bird powder day. It could be a stormy 15 hour mountaineering slog. Or, it could be just a day where you're laughing with (or at) your friends.

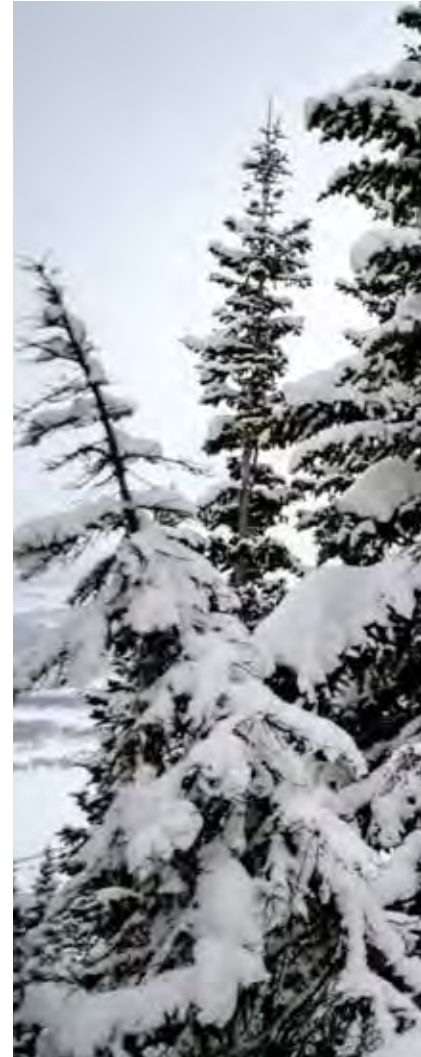

BY HADLEY HAMMER



**HADLEY HAMMER**  
JACKSON HOLE, WY  
MODEL: PANDORA 110



## PANDORA 110

Playful and agile without sacrificing control, the 110 is the perfect ski to transition effortlessly from surfy pow to precise hardpack.



<b>LENGTHS:</b>	152, 162, 172, 179	<b>CORE:</b>	Maple Lite
<b>SHAPE mm:</b>	142-110-125	<b>BASE:</b>	Sintered
<b>WEIGHT/ PAIR(g):</b>	3,554	<b>FLEX:</b>	Symmetric Flex™
<b>SIDECUT AVG. m:</b>	14.2	<b>GEOMETRY:</b>	5-Cut™
<b>STANCE mm:</b>	-66.3	<b>TECHNOLOGY:</b>	Capwall
<b>PROFILE mm:</b>	10-5-5	<b>EDGE mm:</b>	2.1 x 2



## PANDORA 95

Award-winning shape and design packed into a women's specific profile for fun in all conditions, from fresh powder to on-piste hot laps.



<b>LENGTHS:</b>	152, 162, 172	<b>CORE:</b>	Maple Lite
<b>SHAPE mm:</b>	130-95-115	<b>BASE:</b>	Sintered
<b>WEIGHT/ PAIR(g):</b>	3,000	<b>FLEX:</b>	Symmetric Flex™
<b>SIDECUT AVG. m:</b>	13.8	<b>GEOMETRY:</b>	5-Cut™
<b>STANCE mm:</b>	-62	<b>TECHNOLOGY:</b>	Sidewall
<b>PROFILE mm:</b>	5-3-2	<b>EDGE mm:</b>	2.1 x 2





## SOULMATE 92

A responsive turn shape paired with a smooth ride makes the Soulmate 92 a nice blend of wild child behavior and a refined, graceful personality!



<b>LENGTHS:</b>	151, 158, 165	<b>CORE:</b>	Maple Macroblock
<b>SHAPE mm:</b>	127-92-115	<b>BASE:</b>	Sintered
<b>WEIGHT/ PAIR(g):</b>	2,980	<b>FLEX:</b>	Symmetric Flex™
<b>SIDECUT AVG. m:</b>	14.6	<b>GEOMETRY:</b>	5-Cut™
<b>STANCE mm:</b>	-66	<b>TECHNOLOGY:</b>	Sidewall
<b>PROFILE mm:</b>	3-5-2	<b>EDGE mm:</b>	2.1 x 2

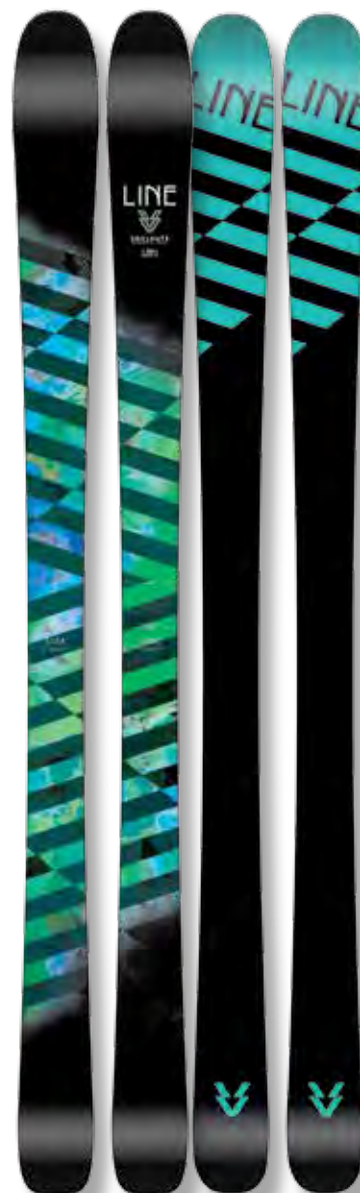

## SOULMATE 86

A sleek profile without being a wimp, the Soulmate packs power when needed and quick edge-to-edge feel for a fun all mountain ride.



<b>LENGTHS:</b>	151, 158, 165	<b>CORE:</b>	Maple Macroblock
<b>SHAPE mm:</b>	125-86-111	<b>BASE:</b>	Sintered
<b>WEIGHT/ PAIR(g):</b>	2,840	<b>FLEX:</b>	Symmetric Flex™
<b>SIDECUT AVG. m:</b>	13.2	<b>GEOMETRY:</b>	5-Cut™
<b>STANCE mm:</b>	-56	<b>TECHNOLOGY:</b>	4D Fibercap
<b>PROFILE mm:</b>	0-4.5-0	<b>EDGE mm:</b>	2.1 x 2



# YOUTH

**RICHARD THOMAS**  
PARK CITY, UT  
MODEL: TOM WALLISCH SHORTY





## SIR FRANCIS BACON SHORTY

Just like the adult Bacon, but in fun size! Affordable yet shredable. Everything's better with bacon! This ski helps 'em beat mom or dad down the hill with all the geometry of the big guy skis with half the weight.



<b>LENGTHS:</b>	145, 155, 165	<b>CORE:</b>	Aspen
<b>SHAPE mm:</b>	133-107-129	<b>BASE:</b>	Extruded Fatty
<b>WEIGHT/ PAIR(g):</b>	3,290	<b>FLEX:</b>	Symmetric Flex™
<b>SIDECUT AVG. m:</b>	14	<b>GEOMETRY:</b>	5-Cut™
<b>STANCE mm:</b>	-30.6	<b>CONSTRUCTION:</b>	4D Fibercap
<b>PROFILE mm:</b>	6-1-6	<b>EDGE mm:</b>	Fatty 2.2 x 2.5



## SICK DAY SHORTY

\*Cough Cough\* Sounds like your family's been exposed to an illness, better take a Sick Day! Award-winning construction paired down for kid specific performance, these skis are the perfect self-medication!



<b>LENGTHS:</b>	152, 162	<b>CORE:</b>	Maple Lite
<b>SHAPE mm:</b>	130-95-115	<b>BASE:</b>	Extruded
<b>WEIGHT/ PAIR(g):</b>	3,120	<b>FLEX:</b>	Directional Flex™
<b>SIDECUT AVG. m:</b>	14	<b>GEOMETRY:</b>	5-Cut™
<b>STANCE mm:</b>	-63	<b>CONSTRUCTION:</b>	4D Fibercap
<b>PROFILE mm:</b>	5-3-3	<b>EDGE mm:</b>	2.1 x 2



## TOM WALLISCH SHORTY

The next Tom Wallisch has to start somewhere and this ski is the ski for the pro-grom! An approachable & affordable ski for the next King of Afterbang!



<b>LENGTHS:</b>	137, 147, 157	<b>CORE:</b>	Aspen
<b>SHAPE mm:</b>	115-85-112	<b>BASE:</b>	Extruded Fatty
<b>WEIGHT/ PAIR(g):</b>	2,640	<b>FLEX:</b>	Symmetric Flex™
<b>SIDECUT AVG. m:</b>	11.5	<b>GEOMETRY:</b>	5-Cut™
<b>STANCE mm:</b>	-40	<b>CONSTRUCTION:</b>	4D Fibercap
<b>PROFILE mm:</b>	1-3-1	<b>EDGE mm:</b>	Fatty 2.2 x 2.5



## GIZMO

Great look, tough construction and matched for Groms looking to progress at the speed of light!



<b>LENGTHS:</b>	100, 113, 123, 133, 143	<b>CORE:</b>	Aspen
<b>SHAPE mm:</b>	97-76-90, 101-80-94	<b>BASE:</b>	Sintered
<b>WEIGHT/ PAIR(g):</b>	1,662	<b>FLEX:</b>	Symmetric Flex™
<b>SIDECUT AVG. m:</b>	15.5	<b>GEOMETRY:</b>	5-Cut™
<b>STANCE mm:</b>	-37	<b>CONSTRUCTION:</b>	4D Fibercap
<b>PROFILE mm:</b>	0-4-0	<b>EDGE mm:</b>	Fatty 2.2 x 2.5

MEN'S FREESTYLE	MODEL	SIZES (CM)	REFERENCE SIZE	TIP/WAIST/ TAIL	5-CUT SIDECUT RADIUS AVERAGE (M)	FLEX	PROFILE (MM)	TIP/TAIL HEIGHT (MM)	RUNNING SURFACE LENGTH (MM)	STANCE BACK FROM CENTER (MM)	WEIGHT (G/SKI)
	Pescado	180	180	158-125-147	19	Medium	20-4-1	90/30	1495	-80	1950
	Eric's Magnum Opus	188	188	148-124-146	17	Medium	12-3-12	64/64	1542	-20	1950
	Mordecai	179, 186, 193	186	141-114-138	17	Medium	15-5-15	66/66	1525	-21	2029
	Sir Francis Bacon	178, 184, 190	184	135-104-131	17.4	Medium	9-3-9	62/62	1520	-21	2045
	Blend	171, 178, 185	178	132-100-122	20.5	Medium	4-4-4	62/62	1440	-40	1935
	Chronic	164, 171, 178, 185	178	121-92-117	19	Medium	2-5-2	52/52	1440	-40	1798
	Tom Wallisch	164, 171, 178	178	117-90-112	20.8	Medium	1-6-1	52/52	1440	-30	1802
	Honey Badger	155, 166, 172, 177	177	120-92-116	19.4	Medium	3-3-3	50/50	1440	-30	1650
	Tigersnake	157, 164, 171, 178	178	113-88-109	19.9	Medium	3-4-3	50/50	1440	-25	1650

MEN'S FREERIDE	MODEL	SIZES (CM)	REFERENCE SIZE	TIP/WAIST/ TAIL	5-CUT SIDECUT RADIUS AVERAGE (M)	FLEX	PROFILE (MM)	TIP/TAIL HEIGHT (MM)	RUNNING SURFACE LENGTH (MM)	STANCE BACK FROM CENTER (MM)	WEIGHT (G/SKI)
	Sick Day 102 Tourist	179, 186	179	135-102-120	17.1	Medium	8-4-3	57/26	1515	-75	1560
	Sick Day 110	172, 179, 186	179	142-110-125	18.1	Medium	10-5-5	78/28	1515	-75	2007
	Sick Day 102	172, 179, 186	179	135-102-120	17.1	Medium	8-4-3	57/26	1515	-75	1900
	Sick Day 95	172, 179, 186	179	130-95-115	18.2	Medium	7-5-5	65/27	1515	-70	1852
	Supernatural 115	179, 186, 192	186	145-115-131	21	Stiff	10-5-8	74/32	1550	-80.5	2470
	Supernatural 108	172, 179, 186	179	137-108-126	22.3	Stiff	9-3-6	62/35	1515	-76.5	2141
	Supernatural 100	172, 179, 186	179	132-100-121	21.3	Medium	5-4-3	61/35	1530	-76.5	2068
	Supernatural 92	165, 172, 179, 186	179	131-92-118	19.6	Medium	4-4-1	61/35	1530	-79	1954
	Supernatural 86	165, 172, 179	172	125-86-112	17.8	Medium	3-4-1	61/35	1530	-75.5	1986

WOMEN'S	MODEL	SIZES (CM)	REFERENCE SIZE	TIP/WAIST/ TAIL	5-CUT SIDECUT RADIUS AVERAGE (M)	FLEX	PROFILE (MM)	TIP/TAIL HEIGHT (MM)	RUNNING SURFACE LENGTH (MM)	STANCE BACK FROM CENTER (MM)	WEIGHT (G/SKI)
	Pandora 110	152, 162, 172, 179	162	142-110-125	14.2	Medium	10-5-5	65/27	1340	-66.3	1777
	Pandora 95	152, 162, 172	162	130-95-115	13.8	Medium	5-3-2	65/27	1360	-62	1500
	Soulmate 92	151, 158, 165	158	127-92-115	14.6	Medium	3-5-2	61/35	1320	-66	1490
Soulmate 86	151, 158, 165	158	125-86-111	13.2	Soft	0-4.5-0	50/26	1320	-56	1420	

YOUTH	MODEL	SIZES (CM)	REFERENCE SIZE	TIP/WAIST/ TAIL	5-CUT SIDECUT RADIUS AVERAGE (M)	FLEX	PROFILE (MM)	TIP/TAIL HEIGHT (MM)	RUNNING SURFACE LENGTH (MM)	STANCE BACK FROM CENTER (MM)	WEIGHT (G/SKI)
	Sir Francis Bacon Shorty	145, 155, 165	155	133-107-129	14	Medium	6-1-6	56/56	1219	-30.5	1645
	Sick Day Shorty	152, 162	162	130-95-115	14	Medium	5-3-3	67/27	1360	-63	1560
	Tom Wallisch Shorty	137, 147, 157	147	115-85-112	11.5	Medium	1-3-1	50/50	1140	-40	1320
Gizmo	100, 113, 123, 133, 143	133	101-80-94	15.5	Soft	0-4-0	50/50	1067	-37	831	

MEN'S FREERIDE	MODEL	STICK	FEATURES	BASKET MM	GRIP DIAMETER MM	WEIGHT G (40"/100cm)
	Pollard Carbon	7075 Alum. Adjustable lower, Carbon Upper	Grab Tab / Velcro Strap, Pozi Tip, Machined Shaft texture	60 & 90 - Screwoff	25mm - Wrap	245
	Pollard Paint Brush	7075 Alum. Adjustable	Grab Tab / Velcro Strap	60 & 90 - Screwoff	25mm - Wrap	245
	Whip	Fiberglass	Grab Tab / Velcro Strap	60 & 90 - Screwoff	26mm - Moto	200
	Grip Stick	6061 Alum.	Velcro Strap	60 & 90 - Screwoff	Ergonomic	200

MEN'S FREERIDE	MODEL	STICK	FEATURES	BASKET MM	GRIP DIAMETER MM	WEIGHT G (40"/100cm)
	Wallischtick	6061 Alum.	Grab Tab, Pozi Tip	60 - Screwoff	25mm - BMX	195
	PIN	6061 Alum.	Grab Tab, Adjustable Webbing Strap	60 - Screwoff	25mm - BMX	195
TAC	6061 Alum.	Adjustable Webbing strap	50	23mm - Foam	175	

WOMEN'S	MODEL	STICK	FEATURES	BASKET MM	GRIP DIAMETER MM	WEIGHT G (40"/100cm)
	Hairpin	6061 Alum.	Grab Tab	60 - Screwoff	25mm - Wrap	195

YOUTH	MODEL	STICK	FEATURES	BASKET MM	GRIP DIAMETER MM	WEIGHT G (40"/100cm)
	Get Up	6061 Alum. Adjustable	Adjustable	50	Ergonomic	210

CONSTRUCTION	CORE	EARLY RISE™	EARLY TAPER™	EDGE (MM)	BASE (MM)	FLEX PATTERN	THIN TIP™	MATRIX TYPE	CARBON OLLIEBAND
Sidewall	Partly Cloudy™	Tip / Tail	Tip / Tail	1.7 x 2	Sintered 1.1	Directional	Tip		
Sidewall	Cloud Core™	Tip / Tail	Tip / Tail	1.7 x 2	Sintered 1.2	Symmetric			
Sidewall	Partly Cloudy™	Tip / Tail	Tip / Tail	1.7 x 2	Sintered 1.2	Symmetric	Tip / Tail		
Sidewall	Partly Cloudy™	Tip / Tail	Tip / Tail	1.7 x 2	Sintered 1.2	Symmetric	Tip / Tail		
Capwall	Maple	Tip / Tail		Fatty 2.2 x 2.5	Sintered Fatty 1.7	Symmetric	Tip / Tail		
Capwall	Maple	Tip / Tail		Fatty 2.2 x 2.5	Sintered Fatty	Symmetric	Tip / Tail		
Capwall	Maple	Tip / Tail	Tip / Tail	Fatty 2.2 x 2.5	Sintered Fatty 1.7	Symmetric	Tip / Tail		Carbon Ollieband
4D Fibercap	Bamboo			Fatty 2.2 x 2.5	Extruded Fatty 1.7	Symmetric	Tip / Tail		Carbon Ollieband
4D Fibercap	Aspenlite™	Tip / Tail	Tip / Tail	Fatty 2.2 x 2.5	Extruded Fatty 1.7	Symmetric	Tip / Tail		Carbon Ollieband

Shockwall™	Cloud Core™	Tip / Tail	Tip / Tail	1.7 x 2	Sintered	Directional			
Capwall	Maplelite™	Tip / Tail	Tip / Tail	2.1 x 2	Sintered	Directional	Tip / Tail		
Capwall	Maplelite™	Tip / Tail	Tip / Tail	2.1 x 2	Sintered	Directional	Tip / Tail		
Capwall	Maplelite™	Tip / Tail	Tip / Tail	2.1 x 2	Sintered	Directional	Tip / Tail		
Shockwall™	Maple	Tip / Tail	Tip / Tail	Fatty 2.2 x 2.5	Sintered Fatty	Directional	Tip / Tail	Metal Matrix	Carbon Ollieband
Shockwall™	Maple	Tip / Tail	Tip / Tail	Fatty 2.2 x 2.5	Sintered	Directional	Tip / Tail	Metal Matrix	
Shockwall™	Maple	Tip / Tail	Tip / Tail	Fatty 2.2 x 2.5	Sintered	Directional	Tip / Tail	Metal Matrix	
Sidewall	Maple	Tip / Tail		2.1 x 2	Sintered	Directional	Tip / Tail	Metal Matrix	
Sidewall	Maple	Tip / Tail		2.1 x 2	Sintered	Directional	Tip / Tail	Metal Matrix	

Capwall	Aspenlite™	Tip / Tail	Tip / Tail	2.1 x 2	Sintered	Directional	Tip / Tail		
Capwall	Aspenlite™	Tip / Tail	Tip / Tail	2.1 x 2	Sintered	Directional	Tip / Tail		
Sidewall	Maple	Tip		2.1 x 2	Sintered	Directional	Tip / Tail		
4D Fibercap	Maple	Tip		2.1 x 2	Sintered	Directional	Tip / Tail		

4D Fibercap	Aspenlite™	Tip / Tail	Tip / Tail	Fatty 2.2 x 2.5	Extruded Fatty 1.7	Symmetric			
4D Fibercap	Maple Lite	Tip / Tail	Tip / Tail	2.1 x 2	Extruded 1.3	Directional	Tip / Tail		
4D Fibercap	Aspenlite™			Fatty 2.2 x 2.5	Extruded Fatty 1.7	Symmetric			
4D Fibercap	Aspenlite™			Fatty 2.2 x 2.5	Extruded Fatty 1.7	Symmetric			

30	32	34	36	38	40	42	44	46	48	50	52	
75	80	85	90	95	100	105	110	115	120	125	130	
					ADJUSTABLE							
					ADJUSTABLE							

--	--	--	--	--	--	--	--	--	--	--	--

ADJUSTABLE										
------------	--	--	--	--	--	--	--	--	--	--

### ERIC POLLARD COLLECTION



NEW

Pescado    Magnum Opus    Mordecai    Sir Francis Bacon

### FREESTYLE



NEW

NEW

Tom Wallisch Pro    Blend    Chronic    Honey Badger    Tigersnake

### WOMEN'S

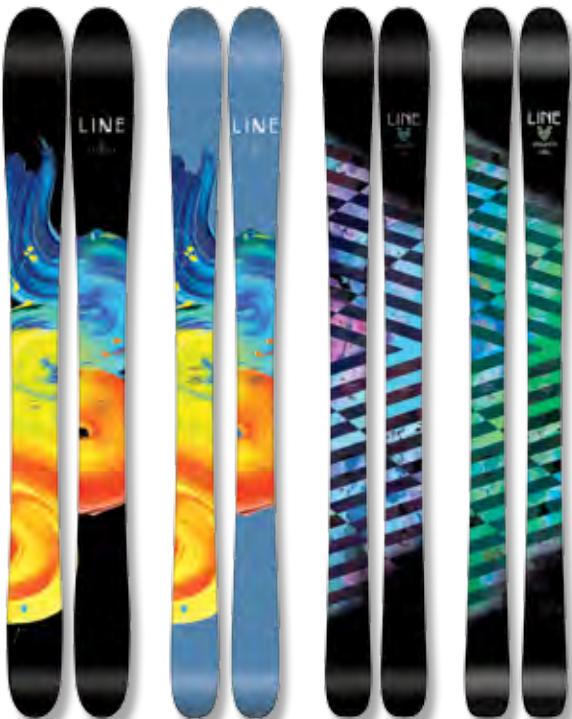

Pandora 110    Pandora 95    Soulmate 92    Soulmate 86

### YOUTH



NEW

Sir Francis Bacon Shorty    Sick Day Shorty    Tom Wallisch Shorty    Gizmo



# MEN'S FREERIDE



Sick Day Tourist    Sick Day 110    Sick Day 102    Sick Day 95



Supernatural 115    Supernatural 108    Supernatural 100    Supernatural 92    Supernatural 86

# POINTY STICKS



Pollard's Carbon    Pollard's Paintbrush    Tom Wallischtick    Grip Stick    Whip    Pin    TAC    Hairpin    Get Up



WE'VE GOT  
YOUR ASSETS  
COVERED

[LINESKIS.COM/DEALERTOOLS](https://lineskis.com/dealertools)

By purchasing our products you've bought your ticket to take the ride of your life! Let our library of media assets and branding support give you the keys to enjoy the astounding sell thru that line dealers have enjoyed for over 2 decades!

*Sincerely,  
Management*



## MEDIA FOR YOU

We've got so much content it's exploding out our assets! Product & action shots, entertaining team & product videos! All easy to embed!



TONS OF PRODUCT & ACTION VIDEOS



PRODUCT, ACTION & LIFESTYLE PHOTOS FOR USE!

## SOCIAL MEDIA CONNECTION

Skiers love us! And can't stop following us! With over 6 Million people reached monthly. Tag us, like us and let's promote each other.



**SOCIAL REACH**  
40 MILLION  
IMPRESSIONS YEAR



**LINE ATHLETE REACH**  
10 MILLION  
IMPRESSIONS YEAR

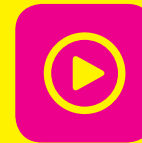

**VIDEO REACH**  
4 MILLION  
VIEWS A YEAR

## PARTNERS

Say howdy to our partners, that expand our reach further!

Level 1



Swindells



Alaska



nimbus

## CONTACTS

We've got digits.

**USA:** 4201 6th Avenue S, Seattle, WA 98108 TF: 888 546 3754 F: 800 972 4066 W: LineSkis.com

**CANADA:** 1 Westside Drive Unit #7, Toronto, ON M9C 1B2, Canada TF: 416 620 4124 F: 416 679 1218

**JAPAN:** 11F, Shibaura Square Bldg. 4-9-25 Shibaura Minato-ku Tokyo 108-0023, Japan T: 03-6858-7822 F: 03-6858-7831

**EUROPE:** Seehaupter Strasse 62, Penzberg 82377, Germany T: 49 8856 901 0 F: 49 8856 901 101

**NORWAY:** Industrivegen 29, N-2836 Biri, Norway T: 47 61134300

Andorra: +34 933002012  
Argentina: 54 11 4711 3349  
Australia: 61 3 95815444  
Austria: 0800293418  
Azerbaijan: +49 88569010  
Belgium: +32 3354 3866  
Belarus: +7 495 9372814  
Bosnia and Herzegovina: +498856 9010  
Bulgaria: +35 9887639372  
Canada: 888 249 7433  
Chile: 56 2 5945015  
China: +86 10 6771 8450  
Croatia: +385 915555976

Czech Republic: +420774791133  
Denmark: +45 9722 4943  
Estonia: +372 6419099  
Finland: +358 10 8386 400  
France: +33 450 642950  
Georgia: +995 32 2369700  
Germany: 08007713458  
Greece: +30 210 685 6946  
Holland: +31 172500066  
Hungary: +361 4877360  
Israel: +972 50 5742717  
Italy: +39 059 744024  
Japan: 81 3 6858 7822

Kazakhstan: +7 7272 61 70 61  
Korea: +82 70 7743 8673  
Kosovo: 377 44 124 955  
Kyrgyzstan: +996 312 694948  
Latvia: +371 67317780  
Lebanon: +961 9 951555  
Lithuania: +370 601 91600  
Macedonia: +389 2 614 7644  
Montenegro: +49 8856 9010  
New Zealand: 64 3 348 9725  
Norway: +47 61 13 43 00  
Poland: +48 502 232 911  
Portugal: +34 933002012

Romania: +40 733 669 339  
Russia: +7 495 789 42 97  
Serbia-Montenegro: +49 88569010  
Slovakia: +420 774791133  
Slovenia: +386 (0) 261 44601  
Spain: +34 933002012  
Sweden: +46 (0)8-544 71960  
Switzerland: +0800 558 197  
Turkey: +49 88569010  
UAE: +971 4 88 03 994  
UK: +44 1905 458184  
Ukraine: +38 044 428 65 32



All inks used contain a percentage of soy base. Printer meets or exceeds all federal Resource Conservation Recovery Act (RCRA) Standards. © 2015 Line Skis LineSkis.com

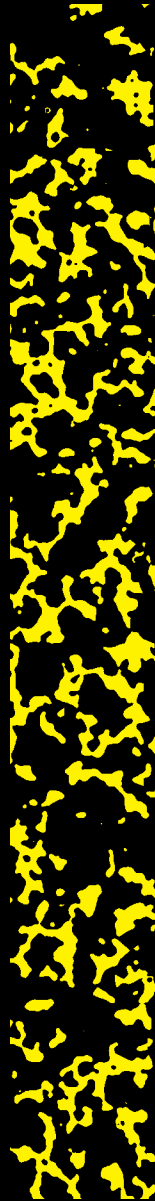

THIS IS THE BACK

**LINE**

LINE® is a registered trademark of Line Skis.