





## CONTENTS *SIDAS WINTER 2020/2021*

<b>ANALYSIS</b>	<i>p. 08-15</i>
<b>WARMTH</b>	<i>p. 16-17</i>
<b>INSOLES</b>	<i>p. 18-39</i>
<b>EQUIPMENT</b>	<i>p. 40-47</i>
<b>INNERBOOTS</b>	<i>p. 48-53</i>
<b>SOCKS</b>	<i>p. 54-61</i>
<b>FITTING SERVICES</b>	<i>p. 62-71</i>
<b>FOOT PRODUCTS</b>	<i>p. 72-75</i>
<b>BOOT &amp; SHOE ACCESSORIES</b>	<i>p. 76-85</i>
<b>MARKETING</b>	<i>p. 86-87</i>



# SIDAS WORLD

**SIDAS: A PARTNER FOR EVERYONE WHO WANTS TO GIVE THEIR FEET THE COMFORT AND PROTECTION THEY NEED FOR EACH NEW SPORT AND EACH NEW DAY**

The success of Sidas' various projects is achieved by combining our passion for sport with the expertise of athletes, orthopaedic centres and sports experts. Sidas offers a wide range of products: insoles, foot protections, shoes, ski liners, socks, thermal socks, insoles and accessories.



## PODIATECH SIDAS MEDICAL

Podiatech offers a full range of equipment and consumables for podiatry and foot care, in order to meet the needs of foot care professionals and their patients.



FOOT ORTHOTICS



FOOT CARE



OPCT LAB

## SIDAS YOUR FOOT COMPANY

Sidas designs 360° foot care products, including comfort solutions adapted for all types of sport and all types of wear.



SKI



OUTDOOR



RUNNING



DAILY LIFE

## THERM-IC

Therm-ic develops thermal products to help users stay warm when participating in winter sports and activities, allowing them to get the most out of their pursuits.



SNOWSPORT



OUTDOOR ACTIVITIES



RUNNING



EVERYDAY OUTSIDE

## corpus.e

Corpus-e creates tools for analysis and data harvesting in order to recommend the best-suited products for each consumer through its digital expertise. Sidas and Corpus-e have combined their skills, expertise and knowledge to develop products which are high-performance and adapt to the specific requirements of stores and customers.



DIGITAL PLATFORM

## ACADEMY Shaving expertise

The Academy is born from the last 40 years of experience of Sidas world. Sidas and Podiatech have always trained their clients to be able to deliver the best custom products. The Academy wants to go further and share with you all our experience. Today the academy wants to be more... and share its experience, thanks to its network gathering the best world experts in their fields.



INFORM & EDUCATE

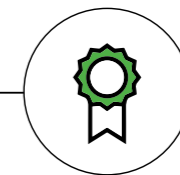

TRAIN & CERTIFY

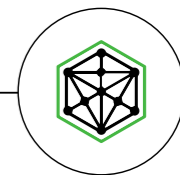

ANIMATE & CONNECT



**THE FIT PROTOCOL IS A UNIQUE PROTOCOL MADE TO SERVE THE END-CONSUMERS; ANSWERING THE NEEDS OF RETAILERS AND INTEGRATING THE BRANDS IN THE PROCESS.**

For 40 years, our know-how, our expertise for training and our retailers follow up; help us to create a protocol that guarantees the best experience for consumers, brands and retailers.

A win win win process between consumers, retailers and brands.

- consumers; feel good because they have great fitted shoes
- retailers: follow a specific protocol (for which they have been trained) to welcome a client and make the sale.
- brands: Are glad that retailers sell properly their products, responding to consumer needs.

To be part of the Fit Protocol program:

- Mandatory products
- Mandatory specific trainings
- Special marketing & communication tools
- Special business conditions

**ENJOY FULLY** 



A new way to enjoy your sport fully



# ANALYSIS

The fondation of a proper fit



# ANALYSIS MEASURING AND ANALYSIS TOOLS

## FEETBOX 3D®

The Sidas & Corpus-e solution, a revolutionary new system: FEETBOX® 3D

Our AIM: to give your clients an in-store experience, in order to enhance your business and services. The plate is equipped with a 360° camera that scans your feet and legs up to the knees, in order to obtain a 3D model of them. You can see all the measurements of your feet (length, width, thickness), ankles and calves on the screen. The system makes it possible to simulate the fitting of a customised insole and shoe whilst taking into account the thickness of the sock. After connecting to the database of footwear sold in your shop and a chat with your customer; Feetbox® 3D makes it possible to simulate fitting shoes that are suitable for your customer's feet, in accordance with their constraints, needs and budget. By virtually fitting the shoe on the feet, it also makes it possible to see the different areas where the feet are deformed that need to be considered. An unrivalled experience for the client and it saves you time. Using Feetbox® 3D gives the consumer a unique experience.



- Ref. CMAFEETBOX3DPR    Ref. 313081101    3D Scanner Feetbox 3D, computer, kiosk, 25 pairs of socks
- Ref. CMAFEETBOX3D    Ref. 312658101    3D Scanner Feetbox 3D, 25 pairs of socks
- Ref. CMAFEETBOX3DCOMP    Ref. 313082101    All in one computer/touch screen



FEETBOX®  
3D MOVIE

### UNIQUE PROCESS

- Put on a pair of special socks.
- Scans both feet simultaneously up to the knee, in only 20 seconds.
- Analysis and calculation of anatomic data regarding
  - FEET VOLUME
  - FEET PRESSURE
  - LEG ALIGNMENT
  - FUNCTION COMPARED TO THE AVERAGE
- Fitting Tab: visualisation of feet with insoles, socks and shoes.
- Access to a database of the shoes available in shops.
- Virtually try on the shoes recommended by the shop's expert, which are suitable for your feet, your needs and your constraints. See the adjustment as it's made.
- Actually try on the complete solutions proposed by the shop expert to check that the footwear chosen is suitable.

1. 3D Scanner
2. Pressure platform
3. Mover
4. Sock storage
5. Screen
6. Magical socks

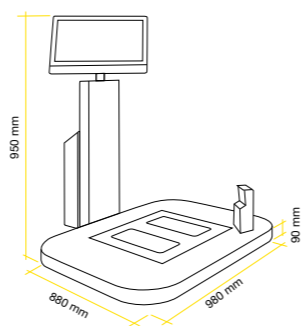

# ANALYSIS MEASURING AND ANALYSIS TOOLS

## UNIQUE SOFTWARE

2 versions available: SHOOIQ Ski & SHOOIQ Ski BF.

### SHOO IQ SKI

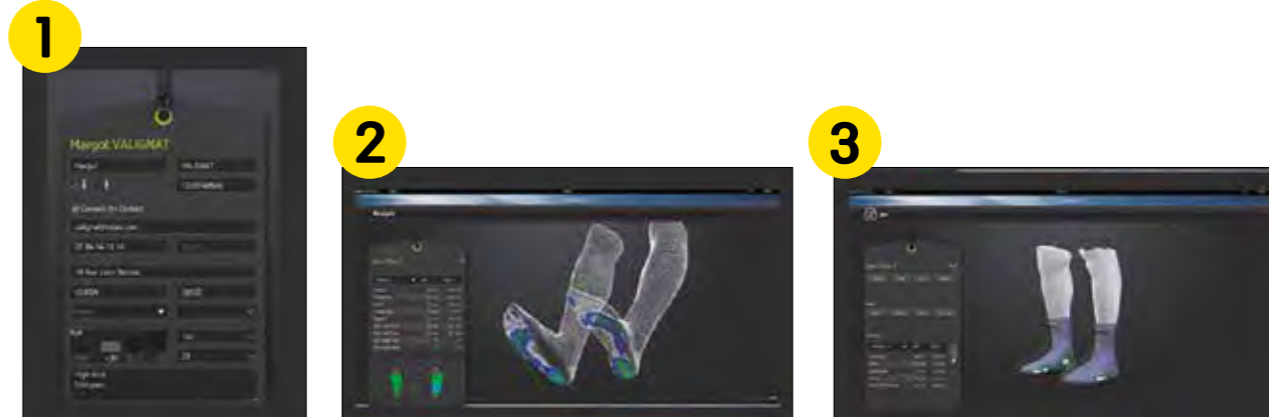

**REAL DATA BASE  
CENTRALIZATION**  
in a specific file  
for each consumer.

**ANALYSE: GIVES ANATOMICAL FOOT  
DATA COVERING**

- foot volumetry;
- foot pressure;
- leg alignment;
- compare to average function.

**FITTING TAB**  
Visualisation of the foot with insoles,  
socks, liners or shells.



### SHOO IQ SKI BF

Includes the SHOOIQ SKI software (step 1, 2 & 3).



**SKI BOOTS DATA BASE**  
Access to CORPUS-E ski boots data  
base.

**TRY ON**  
Possibility to try on ski boots and  
visualization of the fitting.

**6 STOCK**  
Possibility to synchronise  
the stock of the shop  
with the software.



# ANALYSIS MEASURING AND ANALYSIS TOOLS

## FEETBOX®

Ref. CMAFEETBOX3F-V2

Ref. 313359101

With this tool, your advice will be faster and clearer, and time spent using the Feetbox® creates an excellent opportunity to discuss individual foot problems and expectations with the customer. With just a single analysis, it will allow you to suggest a shoe and justify the suggestion of a suitable 3Feet® insole. Thanks to this exclusive Sidas technology, this analysis can be performed whilst the customer is wearing their socks!

- A sleek design suitable for any shop environment.
- Multi-unit length measurements.
- Efficient indication of foot volume: narrow / standard / wide.
- Quick and easy installation.
- No moving parts: system reliability.
- Wifi connection for online technical support.
- VGA connection for use with an external display.

## CONNECT®

Mandatory

The Connect® option is the solution which will enable you to collect your customers' data (measurements, footprints, types of feet) and enrich your contact database (access to all e-mail addresses and statistics on ShoolQbox's website).

- Screen with contact form at the end of the analysis
- Easy-to-use
- Enhanced, personalised experience for the client

## OPTION SHOE SELECTOR

NEW

Thanks to the measurements taken by Feetbox 2D, complemented customer questionnaire, the Shoe Selector allows for an efficient and personally tailored ski boots based on the models pre-selected by the retailer.

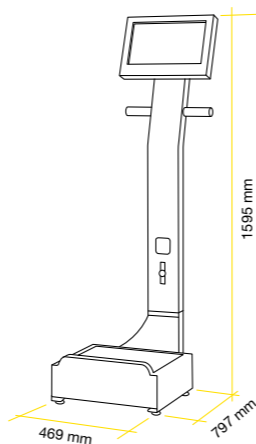
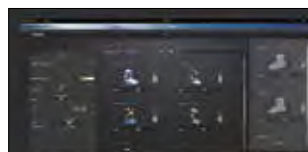

### 15» TOUCH SCREEN



### SPOTLIGHT FOR IMAGE CAPTURE



### 3 HD WEBCAMS



### SENSITIVE FOOTPRINT PAD

### SMALL CARPET (included)

## MARKETING TOOLS



### FEETBOX® MAXI CARPET

Ref. CMKFEETBMAXCAR  
Ref. 311012101  
Dimensions : 135 x 160 cm

### TRANSPORTATION CASE

Ref. CMAFEETBOXSID\_CAIS  
Ref. 315563101



### PROTECTION FRAME

Ref. CZFBPLEXIPROTECTION  
Ref. 314578101



### FEETBOX® CUBE

Ref. CMKFEETBCUBE  
Ref. 311013101  
Dimensions : 48 x 48 x 48 cm

# ANALYSIS MEASURING AND ANALYSIS TOOLS

## FEETBOX® PROCESS



Step onto the feet box.  
Touch the screen to begin.



Position feet on the marks.  
Touch the screen to begin the analysis.

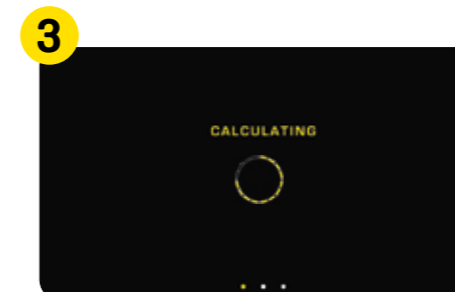

Wait 8 to 12 seconds for calculation.



Foot measurement: Length, width, type of foot and shin alignment.



Optimal and dynamic analysis of the footprint. See the foot print on screen.



Discover the Feetbox® video.



# ANALYSIS MEASURING AND ANALYSIS TOOLS

## PODOSCOPE V2

Ref. APODOSIDAS      Ref. 109305101

A podoscope that has a mirror system for viewing the foot print.  
Sold with a remote control to facilitate use.



## SKI ANALYSE STATION

Ref. COUCHSKANSTA15      Ref. 38047201

This analysis station offers the technician all the equipment necessary to conduct a fast and effective analysis of the skier's foot in order to facilitate the choice of a shell and recommend a boot-fitting solution. It consists of a double measurer L / XL (choice of shell size and model), a mobile alignment laser (for verifying alignments and recommending the insole) and a boot-spreader for validating the shell volume. The Fit Sticks are not included.



## FIT STICKS + LIGHT

Ref. CCHDCFITSTIC      Ref. 32958001

3 sticks of varying thickness (diameter: 10 mm - 15 mm - 20 mm) for measuring the space available in the boot and to confirm the choice of shell size. Sold as a kit or alone.



## SKI ANALYSE STATION PROCESS



## FEET REVELATOR™ PROCESS

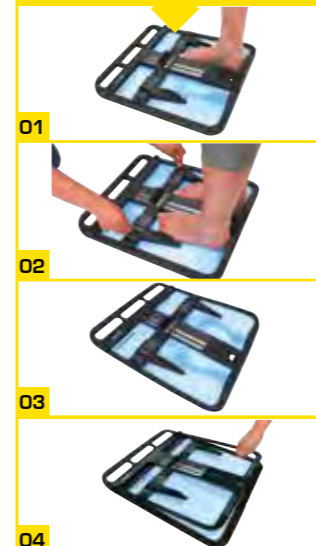

## FEET MEASURER PROCESS



## FOOT SIZER PROCESS



# ANALYSIS MEASURING AND ANALYSIS TOOLS

## FEET REVELATOR™

Ref. ABFEETREVE12      Ref. 32953601

With the Feet Revelator™ you can determine your customer's foot type and characteristics in an instant. It not only measures the length and width of any foot but also reveals the footprints. Simple to use: just open and close to erase your customer's footprints.



## FEET MEASURER

Ref. ABMES-SPORT-DBLE12      Ref. 36010101

Instrument that measures the length and width of both feet. 4 sizing systems (EUR/US/UK/MP). Simple to use and robust (plastic). Includes a handle for easy carrying.



## FOOT SIZER

Ref. ABMESPORT12-1FOOT      Ref. 36010001

Instrument that measures the length and width of the right foot. 4 sizing systems (EUR/US/UK/MP). Simple to use and robust (metal).







**NO MORE COLD FEET DURING YOUR SKI DAYS WITH OUR HEATING PRODUCTS. DISCOVER OUR SOLUTIONS :**



**INSOLES**

*More informations page 38*



**TONGUE**

*More information page 52*



**SOCKS**

*More information page 61*

# WARMTH

How do you want your heat?



# INSOLES

Supporting the perfect fit



# 3D

With our extensive knowledge about both the foot and boot fitting, utilising our database of over 400,000 scanned feet, we can select the most suitable insole form to provide optimal foot support. Our pre-moulded 3D insoles ensure foot stability within the ski boot, and ultimately greater comfort.



## MARKETING TOOLS



**SIDAS BOOTFITTING CUBE**

Ref. CMKSIDASBFCUBE15  
Ref. 38048401



**SIDAS CUBE**

Ref. CMKSIDASCUBE12  
Ref. 35476601



**SIDAS CUBE PLIABLE**

Ref. CMKSIDASBFCUBE16  
Ref. 919545101

## RENTAL

### SANISOLE 3D

Ref. (box of 10) CSESISAN3D13

Ref. (box of 10) 360042

An insole designed to provide good foot support when practicing winter sports. It has an antibacterial top layer.

- 1. Antibacterial MerryMesh top layer
- 2. EVA shore A 40: Comfort & lightness

SIZES: 18, 19, 20, 21, 22, 23, 24, 25, 26, 27, 28, 29, 30, 31, 32

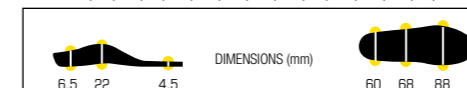

### WINTER 3D RENTAL

Ref. (box of 10) CSESIREN16

Ref. (box of 10) 309501000

A 3D insole that provides enhanced comfort and hygiene (sanitized treatment). This insole is available in 15 sizes and can be integrated into all the rental boots, or bought by the customer in the shop.

- 1. Highly resistant merry mesh with an antibacterial coating for enhanced hygiene
- 2. 3mm EVA foam: Comfort
- 3. 3D EVA shell: Optimum protection and support on the slopes for enhanced comfort, enjoyment and reduced fatigue

SIZES: 18, 19, 20, 21, 22, 23, 24, 25, 26, 27, 28, 29, 30, 31, 32

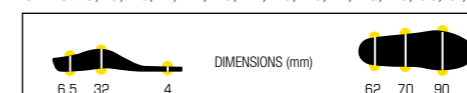

**DEMO SEAT**

Ref. CMKDEMOSEATFUL19  
Ref. 317707101

- Includes 3 empty demo boxes for demo kits in 10 sizes
- Sizes: Height: 664mm / Width: 350 mm / Length 455 mm



**DEMO BOX**

Ref. CMKDEMOBOX19  
Ref. 315705101



# 3D

## WINTER 3D MERINO

Ref. CSE3DWINMERI20      Ref. 319652000

The Winter 3D Merino insole was designed to provide maximum comfort and warmth during winter activities. The insole's anatomical design helps distribute the load underfoot, limiting pressure points. The EVA foam heel absorbs any shocks related to your chosen activity. The merino covering and insulating foil provide warmth and insulation, even during low intensity activities.

- 1. EVA FOAM: instant comfort for the entire foot
- 2. MERINO COVERING: Warmth and odour absorption
- 3. ALUMINUM FOIL: insulation
- 4. EVA shell: Foot support and stability
- 5. EVA heel pad: Cushioning

SIZES XS-S-M-L-XL-XXL



NEW

## WINTER 3D PERFORMANCE

Ref. CSE3DWINPERF20      Ref. 319651000

Inspired by our developments for world cup skiers, the Winter 3D Performance insole has been designed to improve pressure transmission for the skier and heel stability within the boot. These factors allow the skier to be more precise when carving while also providing improved comfort. The insulating aluminium film and EVA foam provide comfort and warmth for the feet, which is an additional bonus for day-long skiing sessions.

- 1. TPU shell: Foot support and pressure distribution
- 2. EVA foam: Comfort
- 3. Microfibre covering: Comfort and anti-slip
- 4. Aluminum foil: insulation
- 5. Heel reinforcements: Forefoot stability
- 6. EVA heel pad: Shock absorption

SIZES XS-S-M-L-XL-XXL



NEW

### MARKETING TOOLS



DEMOKIT WINTER 3D MERINO

10 sizes  
Ref. Left: CSE3DDKWIMERI20L  
Ref. Left: 319778101  
Ref. Right: CSE3DDKWIMERI20R  
Ref. Right: 319779101

DEMOKIT NORDIC 3D

Ref. CSE3DDKXCNRD17  
Ref. 312041101

DEMOKIT 3D PERFORMANCE

10 sizes  
Ref. Left: CSE3DDKWIPERF20L  
Ref. Left: 319776101  
Ref. Right: CSE3DDKWIPERF20R  
Ref. Right: 319777101



### WINTER POP

POP WINTER 3D MERINO  
Ref. CSE3DMKPOPWIME  
Ref. 319781101

POP WINTER 3D PERFORMANCE  
Ref. CSE3DMKPOPWIPF  
Ref. 319780101



**IN STORE 3D INSOLES MERCHANDISING**

Ref FR. CSE3DMKPOPME20\_05  
Ref FR. 319844104  
Ref EN. CSE3DMKPOPME20\_02  
Ref EN. 319844102  
Ref DE. CSE3DMKPOPME20\_01  
Ref DE. 319844101



SKIBOOSTS INSOLES POS

Ref FR. CSE3DMKPOSSK20\_05  
Ref FR. 319843104  
Ref EN. CSE3DMKPOSSK20\_02  
Ref EN. 319843102  
Ref DE. CSE3DMKPOSSK20\_01  
Ref DE. 319843101

Take full advantage of your activity

**#KEEPPON SKIING**

**3D NORDIC**  
Stability & movement control,  
power transfer, sensation  
Stabilité et contrôle de mouvement,  
transfert de puissance, sensation

3D NORDIC POSTER

Available on the extranet

## NORDIC 3D

Ref. CSE3DXCNORD17      Ref. 311900000

Preformed insoles specially designed for Nordic skiing (classic and skating). Get the most out of your sport during the different phases: propulsion, gliding and manoeuvring. These light and comfortable insoles provide you with precision and momentum. The 3D shell gives stability to the foot, and maximises stability while gliding and manoeuvring. The kick pad optimises and boosts the propulsion phase.

- 1. Top cover: Anti friction's resistance
- 2. comfort layer
- 3. 3D shell: Stability & movement control
- 4. Kick pad: Power transfert & sensation

SIZES XS-S-M-L-XL-XXL





# 3Feet®

Feet differ in three main ways; their shape, movement and pressure. Despite these differences, they can generally be grouped into three categories, each with their own distinct needs: High arch feet - Mid arch feet - Low arch feet. The biomechanical construction of the 3Feet® range is therefore adapted to three different types of arches.



## 3FEET® PROCESS



### MARKETING TOOLS

#### 3FEET WINTER POP

Ref. CMK3FWIP0P12\_MU  
Ref. 32955901



#### 3FEET WINTER FACING

Ref. CMK3FWIFAC12\_MU  
Ref. 32956301



#### DEMOKIT WINTER 3FEET®

10 sizes - 22 to 31

**WINTER 3FEET® HIGH**  
Ref. Left. CSE3FDKWINTHI19L  
Ref. Left. 317694101  
Ref. Right. CSE3FDKWINTHI19R  
Ref. Right. 317695101

**WINTER 3FEET® MID**  
Ref. Left. CSE3FDKWINTMI19L  
Ref. Left. 317698101  
Ref. Right. CSE3FDKWINTMI19R  
Ref. Right. 317699101

**WINTER 3FEET® LOW**  
Ref. Left. CSE3FDKWINTLO19L  
Ref. Left. 317697101  
Ref. Right. CSE3FDKWINTLO19R  
Ref. Right. 317696101



# 3Feet®

## 3FEET® WINTER HIGH

Ref. CSE3FWI12-HI

Ref. 329503

Specifically designed for high arch feet.  
Need: support.  
3Feet® answer: Optimised pressure distribution.  
- Aluminium film for insulation.  
- Anatomical construction adapted to high arch feet.  
- Large foam pad for greater cushioning.

1. Velvet topcover: comfort & durability
2. Eva shell high arch shape: foot support & pressure distribution
3. Eva pad: cushioning
4. Aluminium film: insulation

SIZES XS-S-M-L-XL-XXL



## 3FEET® WINTER MID

Ref. CSE3FWI12-MI

Ref. 329502

Specifically designed for medium arch feet.  
Need: support.  
3Feet® answer: Optimised pressure distribution.  
- Aluminium film for insulation.  
- Anatomical construction adapted to medium arch feet.  
- Large foam pad for greater cushioning.

1. Velvet topcover: Comfort & durability
2. EVA shell mid arch shape: Foot support & pressure distribution
3. EVA pad: Cushioning
4. Aluminium film: Insulation

SIZES XS-S-M-L-XL-XXL



## 3FEET® WINTER LOW

Ref. CSE3FWI12-LO

Ref. 329501

Specifically designed for low arch feet.  
Need: support.  
3Feet® answer: Optimised pressure distribution.  
- Aluminium film for insulation.  
- Anatomical construction adapted to low feet.  
- Large foam pad for greater cushioning.

1. Velvet topcover: Comfort & durability
2. EVA shell LOW arch shape: Foot support & pressure distribution
3. EVA pad: Cushioning
4. Aluminium film: Insulation

SIZES XS-S-M-L-XL-XXL





# 3Feet®

## 3FEET® MERINO HIGH

Ref. CSE3FME18\_HI

Ref. 314178100

Anatomical insoles adapted high-arched foot. Ideal hybrid top cover : synthetics fibers (40%) will guarantee resistance and durability, the merino wool (60%) will reduce odor and assure an optimal thermoregulation.

1. Hybrid Merino top cover: Thermoregulation & Absorbs odours
2. Eva shell high arch shape: foot support & pressure distribution
3. Aluminium layer: Insulation
4. EVA PAD: Heel cushioning

SIZES XS-S-M-L-XL-XXL



## 3FEET® MERINO MID

Ref. CSE3FME18\_MI

Ref. 314178200

Anatomical insoles adapted mid-arched foot. Ideal hybrid top cover : synthetics fibers (40%) will guarantee resistance and durability, the merino wool (60%) will reduce odor and assure an optimal thermoregulation.

1. Hybrid Merino top cover: Thermoregulation & Absorbs odours
2. Eva shell mid arch shape: foot support & pressure distribution
3. Aluminium layer: Insulation
4. EVA PAD: Heel cushioning

SIZES XS-S-M-L-XL-XXL



## 3FEET® MERINO LOW

Ref. CSE3FME18-LO

Ref. 314178300

Anatomical insoles adapted low-arched foot. Ideal hybrid top cover : synthetics fibers (40%) will guarantee resistance and durability, the merino wool (60%) will reduce odor and assure an optimal thermoregulation.

1. Hybrid Merino top cover: Thermoregulation & Absorbs odours
2. Eva shell low arch shape: foot support & pressure distribution
3. Aluminium layer: Insulation
4. EVA PAD: Heel cushioning

SIZES XS-S-M-L-XL-XXL



### MARKETING TOOLS



#### DEMOKIT WINTER 3FEET®

10 sizes- 22 to 31

#### 3FEET® MERINO HIGH

Ref. Left. CSE3FDKMERIHI19L

Ref. Left. 317702101

Ref. Right. CSE3FDKMERIHI19R

Ref. Right. 317703101

#### 3FEET® MERINO MID

Ref. Left. CSE3FDKMERIMI19L

Ref. Left. 317701101

Ref. Right. CSE3FDKMERIMI19R

Ref. Right. 317700101

#### 3FEET® MERINO LOW

Ref. Left. CSE3FDKMERILO19L

Ref. Left. 317705101

Ref. Right. CSE3FDKMERILO19R

Ref. Right. 317704101



#### 3FEET® MERINO POP

Ref. CMK3FMERIPOP18

Ref. 314377101



#### 3FEET® MERINO FACING

Ref. CMK3FMERIFAC18

Ref. 314379101



#### 3FEET® MERINO POSTER

Available on the extranet



MERINO

# Stay warm with merino wool..

**3FEET® MERINO**



# FLASHFIT™

The Flashfit™ technology allows 75% customization of your insoles in only a few minutes. The bootfitter heats a pre-shaped insole and fits it to your foot in less than 5 minutes. Only part of the insole can be fully customized to your foot, the other pre-shaped part remains unchanged when heated. With Flashfit™ insoles, you have more power, control and comfort.

**ECO FOAM PAD**  
COMFORT & DURABILITY

**TRANSFLUX® C REINFORCEMENT**  
SUPPORT & STABILITY

**IONMESH® TOPCOVER**  
CUSHIONING & ANTIBACTERIAL

**PODIAFLEX® N**  
SUPPORT & STABILITY



## FLASHFIT™ PROCESS



### MARKETING TOOLS



#### DEMOKIT WINTER +

Ref. CSESPDKWIN12  
Ref. 32953901

#### DEMOKIT WINTER +SLIM

Ref. CSESPDKWSL12  
Ref. 32954001



# FLASHFIT™

## WINTER+

Ref. CSESPWINT12

Ref. 329504

Pre-shaped insoles designed for winter sports such as skiing and snowboarding, for optimum comfort. Foot support, stability and prevention of overheating and fatigue. Can also be customised to your feet in less than 10 minutes using Flashfit™ technology for additional comfort.

- 1. Ionmesh® topcover: Cushioning & antibacterial
- 2. Transflux® C reinforcement: Support & stability
- 3. Podiaflex® N: Support & stability
- 4. Eco foam pad: Comfort & durability

SIZES XS-S-M-L-XL-XXL

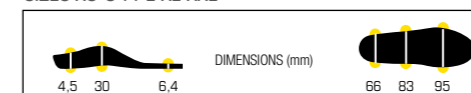

## WINTER+ SLIM

Ref. CSESPWINSL12

Ref. 329505

Pre-shaped insoles for winter sports such as skiing and snowboarding, designed for slim-fitting footwear. Foot support, stability, prevention of overheating and fatigue. Can also be customised to your feet in less than 10 minutes using Flashfit™ technology for additional comfort.

- 1. Ionmesh® topcover: Cushioning & antibacterial
- 2. Transflux® C reinforcement: Support & stability
- 3. Podiaflex® N: Support & stability

SIZES XS-S-M-L-XL-XXL

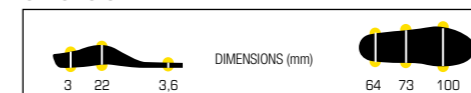

## COMFORT + MERINO

Ref. CSESPCOMFME18

Ref. 314135000

Pre-shaped insoles designed for outdoor activities. Ideal hybrid top cover : synthetics (40%) fibers will guarantee resistance and durability, the merino (60%) wool will reduce odor and assure an optimal thermoregulation. Personalised to your feet using flashfit™ technology.

- 1. Hybrid merino top cover: Thermoregulation & Absorbs odours
- 2. Transflux®: Flexibility & comfort
- 3. Transflux® C Reinforcement: Foot support & stability
- 4. Transflux®: Arch support

SIZES XS-S-M-L-XL-XXL



# Custom

The Custom technology offers complete customisation of your insoles. Starting with a flat insole, the bootfitter heats the insoles and then moulds them. When it is placed on your footprint, the Custom insoles hugs the shape of your feet for the highest levels of comfort and support.



**CUSTOM PROCESS**



# Custom

## WINTER CUSTOM COMFORT

Ref. CSECUWICOMF14      Ref. 372478

The Custom Comfort insole is designed specifically for skier comfort, particularly forefoot comfort, through use of soft materials. This fully thermoformable insole perfectly matches the shape of the skier's foot, providing heel stability and underfoot load distribution, ensuring precise control of the skis. Its AMF microfibre covering guarantees day-long comfort for the skier.

1. AMF topcover: Soft touch & easy step in
2. Podialène foam 2.5 mm: Cushioning across the entire insole
3. Expertene padding: Optimal comfort
4. Podiafix® reinforcement: Foot stability & control
5. Transflux® reinforcement: Back foot stability
6. Podiaflex: Comfort & softness

SIZES XS-S-M-L-XL-XXL



## WINTER CUSTOM RACE MERINO

Ref. CSECUWIRACME18      Ref. 314133000

Ski Race Merino insole designed for winter sports, guarantee stability, precision and fatigue prevention. Ideal hybrid top cover : synthetics fibers (40%) will guarantee resistance and durability, the merino wool (60%) will reduce odor and assure an optimal thermoregulation.

1. Hybrid Merino top cover: Thermoregulation & Absorbs odours boots
2. Narrow shape: For narrow boots
3. Transflux® reinforcement: Foot support & rigidity
4. Podiafix®: Precision

SIZES XS-S-M-L-XL-XXL



## WINTER CUSTOM PRO

Ref. CSECUWIPR12      Ref. 329508

The Custom Ski Pro is designed for skiers who are looking for incomparable comfort and performance. Constructed using new materials that mould more easily to the feet.

1. Ionfoam® topcover: Cushioning & antibacterial
2. Transflux® reinforcement: Support & stability
3. Transflux®: Support
4. Podiafix®: Precision

SIZES XS-S-M-L-XL-XXL

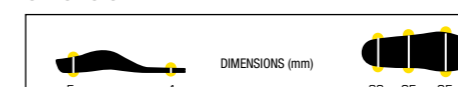





# Custom

## WINTER CUSTOM SKI

Ref. CSECUIWISK12      Ref. 329506

The essential insole. Can be used alone but is most often stabilized with Heel stabs or Transflux® reinforcements.

- 1. Ionfoam® topcover: Cushioning & antibacterial
- 2. Podiaflex® reinforcement: Foot support & stability
- 3. Podiaflex®: Precision

SIZES XS-S-M-L-XL-XXL

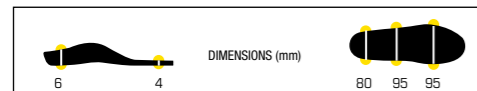

## CUSTOM XC CLASSIC

Ref. CSECUXCLAS17      Ref. 311932000

The Custom XC Classic insole is designed to provide classic Nordic skiers an unparalleled experience in terms of comfort, control and power transfer. The AMF top layer makes it easy to put on; the new Jogtene®Light foam provides boost during all phases of movement and the EVA base can withstand all bending stresses generated when skiing.

- 1. AMF Top cover: Easy step in & Moisture management
- 2. Jogtene® Light foam: Propulsion & dynamism
- 3. PE high density base: Maximal resistance to bending
- 4. Transflux® carbon & Transflux®: Support, stability and support transfer

SIZES XS-S-M-L-XL-XXL

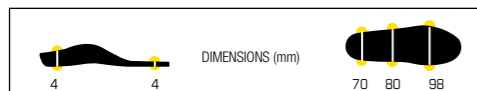

## CUSTOM XC SKATING

Ref. CSECUXSKAT17      Ref. 311933000

The Custom XC Skating insole is designed to provide skating Nordic skiers an unparalleled experience in terms of comfort, control and power transfer. The AMF top layer makes it easy to put on; the new Jogtene®Light foam provides a boost during all phases of movement and the Podiaflex® base controls twisting, providing an optimal power transfer.

- 1. AMF Top cover: Easy step in & Moisture management
- 2. Jogtene® Light foam: dynamic rebound
- 3. Podiaflex®: Twisting control & optimal power transfer
- 4. Transflux® carbon & Transflux®: Support, stability and support transfer

SIZES XS-S-M-L-XL-XXL



### MARKETING TOOLS

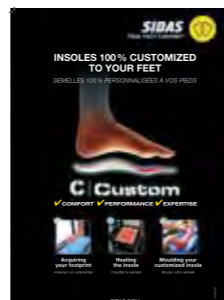

#### CUSTOM POSTER FOR FIT STATIONS

Poster Custom EN DE  
Ref. CMKPOSCUSTOM\_0

Poster Custom EN FR  
Ref. CMKPOSCUSTOM\_05

### HEAT READY PROCESS



#### XC-NORDIC POSTER

Available on the extranet



# Custom

## CUSTOM COMFORT MERINO

Ref. CSECUCOMFME18      Ref. 314134000

The Custom Comfort Merino insole is designed specifically for skier comfort, particularly forefoot comfort, using very soft materials. This fully thermoformable insole perfectly matches the shape of the skier's foot, providing heel stability and underfoot load distribution, ensuring precise control of the skis. Its ideal hybrid covering combines 40% synthetic fibres, guaranteeing strength and durability, with 60% merino wool, which naturally minimises odours and ensures optimal temperature regulation.

- 1. Hybrid merino top cover: Thermoregulation & Absorbs odours
- 2. Podialène foam 2.5 Mm: Cushioning across the entire insole
- 3. Expertene padding: Optimal comfort
- 4. Podiaflex® reinforcement: Foot stability & control
- 5. Transflux® reinforcement: Back foot stability
- 6. Podiaflex: Comfort & softness

SIZES XS-S-M-L-XL-XXL



## WINTER CUSTOM PRO HEAT READY

Ref. CSECUIPROHR19      Ref. 31658700

100% customizable insoles designed for sports of winter (ski, snowboard ...) for an optimal comfort. Stability, precision, performance and prevention of fatigue. Option of heating the sole thanks to Heat Ready technology!

- 1. AMF top cover: soft feeling and easy fitting
- 2. Transflux® reinforcements: foot support & stability
- 3. Podiaflex®: Précision
- 4. Podialène foam: cushioned sole

SIZES XS-S-M-L-XL-XXL

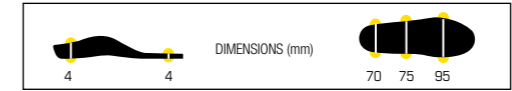

## HEAT READY PACK 10

Ref. T44-0900-003

Pack of 10 pairs of heating elements (powered by Therm-ic) and 10 pairs of external coatings. Note: the Therm-ic warming elements are only compatible with Therm-ic C-Packs batteries.





# INSOLES MODULO RACING

This offer is exclusively reserved to boot-fitting experts. It has been developed by specialists and approved by athletes. This premium offer is used for the customised design of high-performance insoles adapted to skiers' needs and disciplines (both alpine and nordic). Sidas has allowed no compromise in ensuring that it only creates the best possible insoles for athletes and only uses the best materials approved by its R&D team.

Delivered in packs of 5 pairs.

## TOP COVERS (XS - XXL)



**TOP COVER RACING 0.8MM**  
Ref. CSEMODRACRV01 - Ref. 380440  
5 pairs pack



**TOP COVER RACING 1.5MM**  
Ref. CSEMODRACRV02 - Ref. 380441  
5 pairs pack



**TOP COVER RACING 2.5MM**  
Ref. CSEMODRACRV03 - Ref. 380442  
5 pairs pack

## MID LAYER (XS - XXL)



**MID LAYER RACING 2MM**  
Ref. CSEMODRACINT01 - Ref. 380443  
5 pairs pack

## BASE (XS - XXL)



**BASE RACING 0.8MM**  
Ref. CSEMODRACBA02 - Ref. 380445  
5 pairs pack



**BASE RACING 1.6MM**  
Ref. CSEMODRACBA01 - Ref. 380444  
5 pairs pack

## MEDIO (XS - XXL)



**MID FOOT RACING 1.1MM**  
Ref. CSEMODRACRF03 - Ref. 380448  
5 pairs pack



**MID FOOT RACING 1.5MM**  
Ref. CSEMODRACRF02 - Ref. 380447  
5 pairs pack



**MID FOOT RACING 2MM**  
Ref. CSEMODRACRF01 - Ref. 380446  
5 pairs pack

## REAR (XS - XXL)



**HEEL RACING 1.1MM**  
Ref. CSEMODRACSRF01 - Ref. 380449  
5 pairs pack

## PADS (T1-T3)



**PAD RACING 2MM**  
Ref. CSEMODRACPA01 - Ref. 380450  
5 pairs pack

## CUSTOMIZING

### ORDER

Upon request

WE PRINT  
YOUR LOGO HERE

Bootfitter logo  
printed on the top  
cover (10x3cm)



### SMU ORDER

Upon request

WE PRINT  
YOUR LOGO HERE

Bootfitter logo  
printed on the top  
cover (10x3cm)

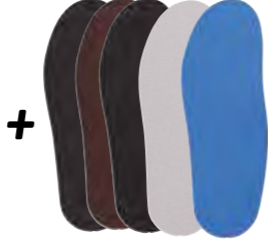

A choice of top cover materials

Choose:  
• the reinforcement  
• the shape



# INSOLES CUSTOM ACCESSORIES

## HEEL BARS

Ref. CSEACSTHEELBARS

Ref. 36004301



## FOOTBED TEMPLATES

Ref. CSEACGABHIVE  
Ref. 866096  
Templates for checking shoe  
or liner size.



## SCISSORS

Ref. P99CISTITANIUM  
Ref. 605586101  
Strong scissors for cutting  
footbeds.



## NEOPRENE GLUE GEL 1L

Ref. P99COLLE1  
Ref. 35251201



## OK NET MOUSSE 150 ML

Ref. SIACOKNET19  
Ref. 818625101  
Cleaning spray for analysis  
and measurement tools,  
machine pads, scan...



Heel bars are the quick way to stabilise the rear foot. They are 10 mm wide and made of shore A70 EVA. They feature an adhesive-coated section which makes them easy to stick to the insole. Sold in packs of 10 pairs.



## TRANSFLUX REINFORCEMENT INSOLES

Sizes: XS - S - M - L - XL - XXL / Sold in pack of 5 pairs

### TX® WHITE (1.5 MM)

Ref. CSEACRETX03

Ref. 893885

### TX® ORANGE (1.5 MM)

Ref. CSEACRETX01

Ref. 893882

### TX® BLACK (1 MM)

Ref. CSEACRETX02

Ref. 893883

### TX® BLUE (1 MM)

Ref. CSEACRETX04

Ref. 893884

### TX® M3 ORANGE (1.5 MM)

Ref. CSEACRETXM3

Ref. 893990

### TX® R3 ORANGE (1.5 MM)

Ref. CSEACRETXR3

Ref. 893991





# INSOLES CUSTOM ACCESSORIES

## HEEL STAB 65

Ref. CSEACSTA65

Ref. 309535000

The Heel Stab 65 stabilizes the Custom insoles. Thanks to its anatomical design, the Heel Stab 65 is easy to position. The Stab requires less grinding.



SIZES XS - XXL



### HEEL STAB PROCESS

## HEEL STAB

Ref. CSEACSTA

Ref. KC2010

Pre-glued PE stabilizer. Easy to fit and grind, for light reinforcement and lateral stability.



SIZES 1 (XS-S) 2 (M-L) 3 (XL)

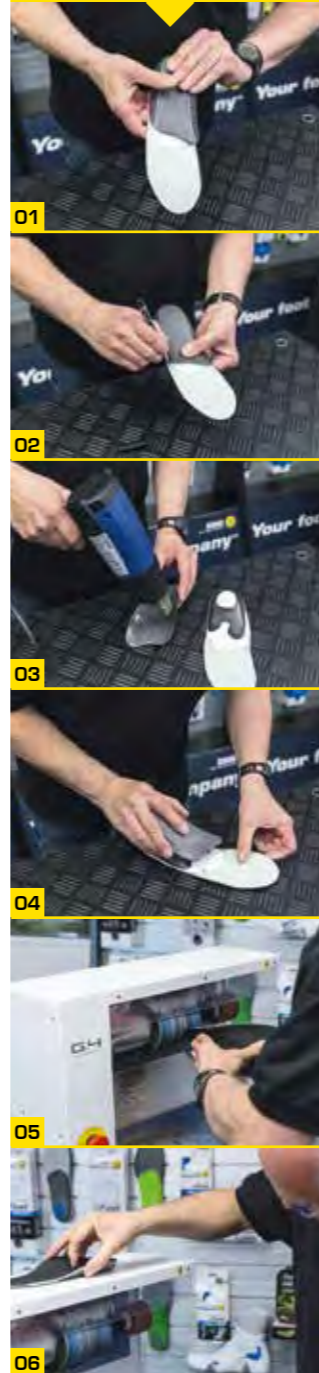

## HEEL STAB STIFF

Ref. CSEACSTASTIF

Ref. 995941

The same concept as the heel stabilizer (Heel stab), but stiffer and available in 4 sizes.



SIZES 1 (XS) 2 (S-M) 3 (L-XL) 4 (XXL)



### CRIST' AIR PROCESS

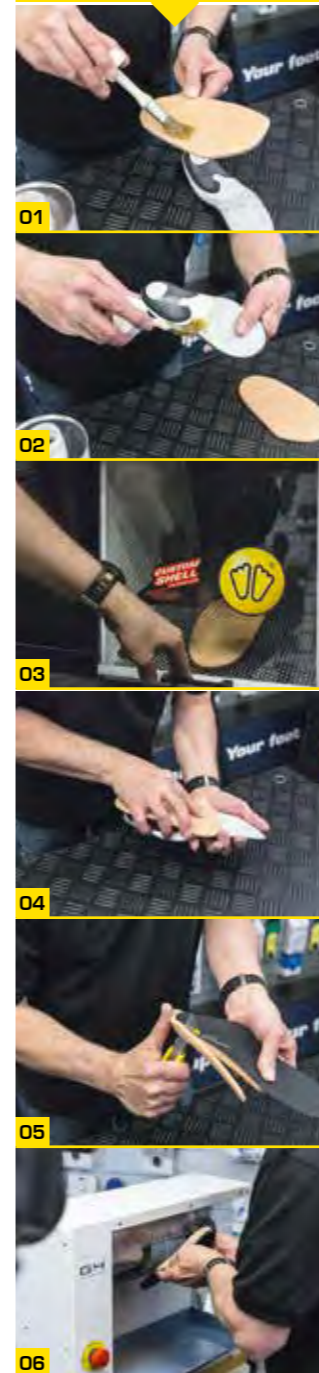

# INSOLES CUSTOM ACCESSORIES

## CRIST' AIR STAB

Ref. CSEACSTCRISR

Ref. 893881

A revolutionary material with unrivalled properties: ultra light (density 100 kg/m<sup>3</sup>); easy to cut and grind. Extra control of both the rear-foot and mid-foot.



SIZES 1 (XS-S) 2 (M-L) 3 (XL)

## HEEL STAB COVER

Ref. CSEACSTACOV

Ref. 353605

EVA coating giving a better finish on the heel stab. Easy to affix to the heel stab thanks to its adhesive. Features: EVA shoreA 70, 1mm black. Sold in packs of 5 pairs.



SIZES T1-T2 / T3-T4



## TAPE AMF ROLL 35cm x 6m

Ref. P01XAMFPL19\_07\_NR

Ref. 611539102

AMF material 35 cm wide, with double-sided adhesive tape. Ideal for perfectly putting on an insole, managing moisture and optimising comfort.

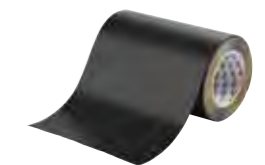

## TAPE IONMESH ROLL 35cm x 6m

Ref. P01XIONMEL19\_06\_RG

Ref. 611540104

IONMESH material 35 cm wide, with double-sided adhesive tape. Ideal for wearing of insole optimally, with good abrasion resistance, and optimising comfort.

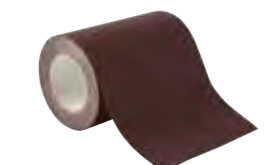

## TAPE CARBON ROLL 35cm x 6m

Ref. P01XEXTCAL19\_NR

Ref. 611542101

EXTENSOUPLE CARBONE material 35 cm wide, with double-sided adhesive tape. Ideal for repairing a shoe, covering an insole.

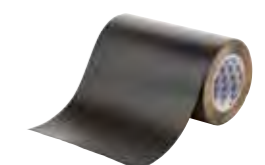



# INSOLES HEAT INSOLES

## 3D POWER HEAT

Ref. CSE3DPOWHEAT20      Ref. 319653000

The heated 3D insole houses highly effective heating elements, providing optimal thermal comfort for any outdoor activity. Its anatomical design distributes the load underfoot, minimising pressure points. Compatible with all the batteries in the Sidas & Therm-ic range.



**NEW**

SIZES XS-S-M-L-XL-XXL

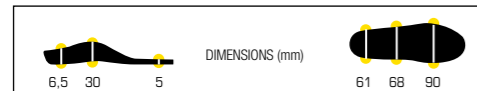

## FLAT POWER HEAT

Ref. CSESIFLAPOWHEAT20      Ref. 319840101

The soft fabric top layer provides good cushioning and insulation from the cold. Multi-size insole with handy trimming lines on the reverse. Compatible with all the batteries in the Sidas & Therm-ic range.



**NEW**

Unique Size

## POWER HEAT ELEMENTS & COVERS

Ref.Heat Elements & covers  
CSECUHECOPOWHEAT20  
319841101

Ref.Heat covers  
CSECUHTOP10  
30787701

Heating elements and covering kit for use with Sidas insoles. The heating elements provide gentle, constant and consistent warmth for optimal thermal comfort. They are ultra thin and fit easily under any type of insole. The external covering covers the heating element and ensures comfort. In the shop, the expert bootfitter fully adjusts the insoles to the feet and the sport, with the added comfort of warmth. Compatible with all the batteries in the Sidas & Therm-ic range. The pack includes 2 top covers and 2 heating element.

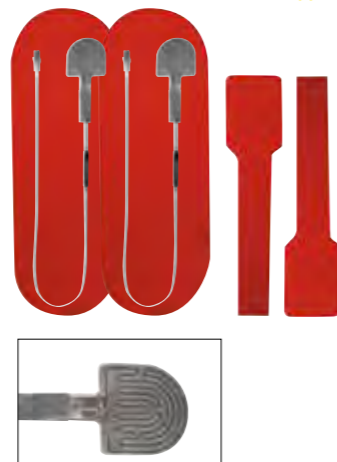

**NEW**



## HEATING ELEMENTS PROCESS



<b>LOW</b>	11h to 13h
<b>MEDIUM</b>	5h to 7h
<b>MAX</b>	3h to 4h



EASY-CLIP



INTERNET WARRANTY



EXTRA POWER FULL



EXTRA POWER FULL

<b>LOW</b>	11h to 13h
<b>MEDIUM</b>	5h to 7h
<b>MAX</b>	3h to 4h



EASY-CLIP



INTERNET WARRANTY



EXTRA POWER FULL



CONTROL THE HEAT

### EXTENSION CORD

- EXTENSION CORD 120cm (1 pair)**  
THERM-IC Ref. T40-0900-005  
THERM-IC Ref. 400900005
- EXTENSION CORD 80cm (1 pair)**  
THERM-IC Ref. T40-0900-003  
THERM-IC Ref. 400900003
- EXTENSION CORD 20cm (1 pair)**  
THERM-IC Ref. T40-0900-004  
THERM-IC Ref. 400900004

INSOLES



# BATTERIES

**C-POWERPack batteries** are suitable for use with Sidas heated insoles, providing up to 13 hours of heat.

- Comes with a single control button
- Pack comes with a USB charger
- Wall charger not supplied

## C-POWER 1300

Ref. HEINCPow1300      Ref. 519771101



The best value for money, this C-POWER 1300 battery pack comes with three heat settings to help keep your feet warm all day long.

- Warm feet for up to 13 hours
- Included: a protective cover for the batteries

3 warming modes for perfect warmth  
11 to 13 hour battery life

Easy to clip on

Extra powerful Lithium-ion battery

Universal charger (connector for use in eu/usa/gb)

2-Year warranty (via internet registration)



## C-POWER 1300B

Ref. HEINCPow1300B      Ref. 519772101



The C-POWER 1300B batteries are the most effective in the range and thanks to the Bluetooth® function you will be able to control the intensity of your heat remotely. Warm feet for up to 13 hours Included: a protective cover for the batteries. The batteries' special Bluetooth® feature enables you to check and regulate the heating level of your insoles on your smartphone using the Therm-ic Heat Control mobile app.

3 Warming modes for adjustable warmth  
11 to 13 hour battery life

Easy to clip on

Extra powerful Lithium-ion battery

Universal charger (connector for use in EU/USA)

2-Year warranty (via internet registration)





# EQUIPMENT



## FLASHFIT™ PROCESS

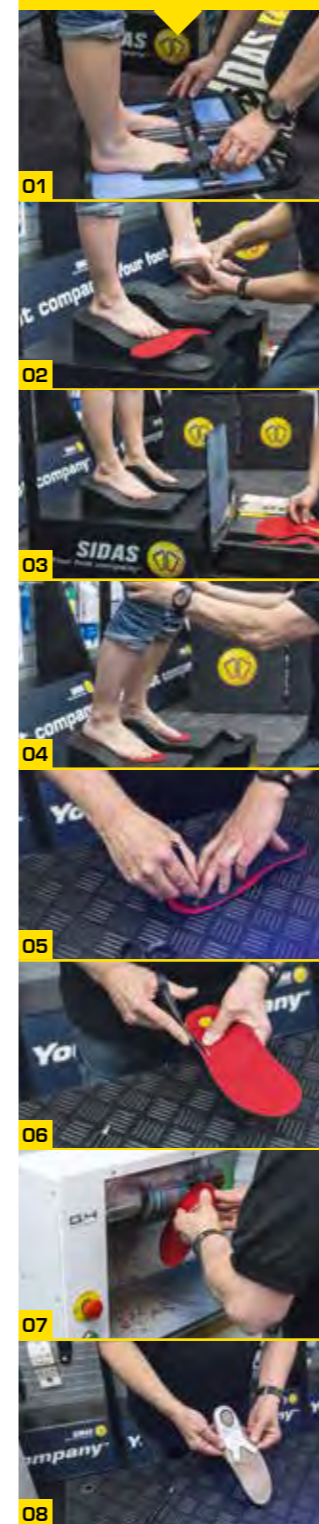

## FLASHFIT™



### FLASHFIT™ PADS

Ref. CMAVAPAD-FF12	Ref. 35476201
Ref. CMAVAPAD-FF-NU	Ref. PADS ALONE = 35476301
Ref. CMAVAPAD-FF-CI	Ref. BOTTOM WEDGE = 35476401
Ref. CMAVAPAD-FF-CL	Ref. SIDE WEDGE = 35476501

The foam pads have two removable reinforcements, are softer and have a new anatomical shape, all of which make moulding easier.  
Available in one size.



### FLASHFIT™ BOX

Ref. 110V: CMAFLASHFIT1	Ref. 99659301
Ref. 220V: CMAFLASHFIT2	Ref. 99659201

The concept that heats Flashfit™ insoles in less than 10 seconds. Easy, fast, compact, unique design.

Dimensions : 12 x 30 x 38 cm - 7 kg





# Custom

## CUSTOM STATION

Ref. CMAJUSTAPREMPK15	Ref. 38045201	CUSTOM STATION PREMIUM PACK (FULL EQUIPPED)
Ref. CMAFITSTAPREM15	Ref. 38045501	FIT STATION PREMIUM (WITHOUT EQUIPMENT)

The premium fit station is the must-have Custom moulding station! Its ergonomic, elegant and simple design lets you promote your boot-fitting activity in-store, particularly the Custom technology.

The design ensures both comfort for the boot-fitter and simple moulding. The station is easy to access for both the customer and the technician. It consists of a comfortable adjustable seat and support bars to ensure stability for the customer during the moulding process. A luminous band emphasises the outline of the station and promotes your boot-fitting space.

In technical terms, the sophisticated station allows you to analyse feet using the fully-integrated podoscope, to heat using the Moduvac and to make imprints using the directly integrated silicone bags.

5-year guarantee on the equipment.  
Lifetime guarantee on metal structure.

Dimensions : 1068 x 925 x 895 mm

1. Fit Station Premium
2. Integrated PODOSCOPE
3. Adjustable seat
4. MODUVAC

Ref. 110V: CMAMODU09-1	Ref. 10757601
Ref. 220V: CMAMODU09-2	Ref. 10757501
Ref. CMAVAPAD09	Ref. 10757701

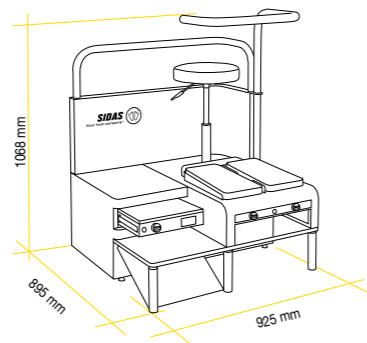

MADE IN FRANCE  
Developed and made in France



## CUSTOM PROCESS



## CUSTOM PROCESS



## CUSTOM STATION COMPACT

Ref. CMAJUSTACMPK15	Ref. 38045301
Ref. CMAFITSTACMPAN15	Ref. 38045601

This fit station is a highly compact unit that combines all the essential elements for customising the design of insoles. It offers the very best function / size / quality ratio.

Its ergonomic metal structure is highly resistant, allowing optimum use of your boot-fitting space. It consists of a seat, an analysis section and a moulding section, all in ideal dimensions for your point of sale or sales visits.

Dimensions : 106 x 710 x 639 mm.

1. Fit Station Compact
2. MODUVAC
3. HDVAC
4. Podoscope
5. Integration of Feet Measurer possible

Ref. 110V: CMAMODU09-1	Ref. 10757601
Ref. 220V: CMAMODU09-2	Ref. 10757501
Ref. 110V: CMAVAHDBLK-1	Ref. 309537101
Ref. 220V: CMAVAHDBLK-2	Ref. 309536101
Ref. APDOSIDAS	Ref. 109305101

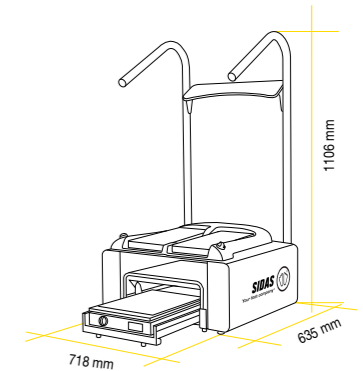

MADE IN FRANCE  
Developed and made in France



# Custom

## CUSTOM STATION 2.1

Ref. CMAUSTA21PK15      Ref. 38045401      (FULL EQUIPPED)

For retailers who want to offer a totally professional service and the best customer experience. The Fit Station is a unit especially designed for boot-fitters. (The HD Vac 2 and the Moduvac are not included and should be bought separately).

Dimensions : 90 x 80 x 89 cm

### 1. FIT STATION

Ref. MBFTSTAT2-1      Ref. 10825701

### 2. HD VAC 2

Ref. 110V: CMAVAHDBLK-1      Ref. 309537101

Ref. 220V: CMAVAHDBLK-2      Ref. 309536101

### 3. MODUVAC

Ref. 110V: CMAMODU09-1      Ref. 10757601

Ref. 220V: CMAMODU09-2      Ref. 10757501

### OPTIONAL:

### 4. LASER ALIGNMENT SYSTEM

Ref. CMAVALASER12      Ref. 36010201

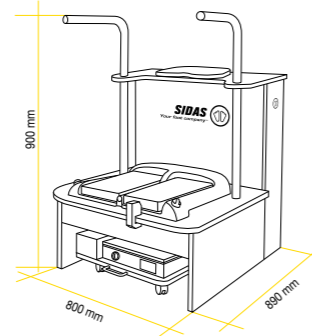

## CUSTOM PROCESS

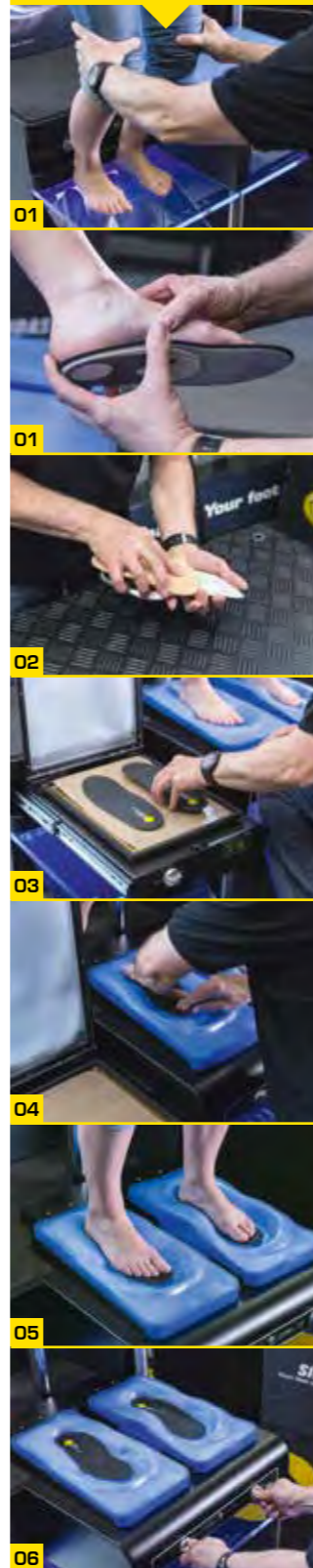

## HD VAC 2

Ref. 110V: CMAVAHDBLK-1      Ref. 309537101

Ref. 220V: CMAVAHDBLK-2      Ref. 309536101

The best just got better. The HDVAC was already the best Custom system on the market, but the HDVAC2 is the most precise system ever made.

The silicon bags can be stretched up to 800% to adapt to any foot shape, the bags are separated for better hip adaptation, and all the controls are on the front making it easier for the boot-fitter to operate.

For retailers who want to offer a complete professional service, this tailor-made product will enhance your custom business line. If you want to bring the best service to your customer, the HDVAC2 is for you.

*The HDVAC 2 is a system for moulding comfort insoles, but cannot replace plantar orthoses fitted by professional foot specialists.*



## MODUVAC

Ref. 110V: CMAMODU09-1      Ref. 10757601

Ref. 220V: CMAMODU09-2      Ref. 107 57501

The new Sidas system to accompany the HDVAC2 system for moulding Custom footbeds. Compact, fast and simple, the Moduvac heats and presses the footbeds using a vacuum system in order to fuse the materials together, and prepare the insoles for moulding. The Moduvac is compatible with all HDVAC systems.



## LASER ALIGNMENT SYSTEM

Ref. CMAVALASER12      Ref. 36010201

Top-quality laser used to check leg alignment. Attaches easily to the Fit Station.



## DUAL LASER ALIGNEMENT SYSTEM FOR STATION PREMIUM

Ref. CMAVALASPREMIUM      Ref. 312039101

The dual laser is designed to fit ergonomically on the Premium Fitstation. It enables the technician to check the shin alignment of the customers and speak to them effectively about the benefits of an insole. The dual laser can be adjusted horizontally. It consists of two independent lasers. Works with 2 batteries (supplied).





# INSOLES EQUIPMENT GRINDERS: BEST SELLERS

## GRAVITY 600

Ref. CMATRGRAV600TOT = GRAVITY 600 TOTEM (WITHOUT EQUIPMENT)  
Ref. 309568101  
Ref. CMATRGRAV600 = GRAVITY 600 (WITHOUT EQUIPMENT)  
Ref. 309569101

- 1 grinding station and 1 finishing station.
- Expanding wheel.
- Self-locking mandrel.
- Very quiet (< 65 dB).
- Torque: 1.8 Nm.
- Power consumption: 600 W.
- Rotation speed: 2850 rpm.
- LED light.
- Storage shelves.
- The grinding area is completely enclosed, preventing mess and pollution of the working environment.
- Easy to clean.

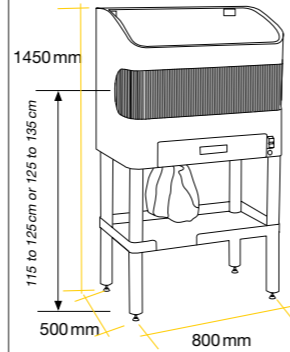

## G1 EVO GRINDER

Ref. PPGTOURG1EVO = G1 EVO-220V WITHOUT ACCESSORIES  
Ref. 617862101  
Ref. PPGTOURG1EVO\_110 = G1 EVO-110V WITHOUT ACCESSORIES  
Ref. 617967101

- Ultra compact drum that fits all workspaces.
- Dual head
- Compact
- Expanding wheel
- Self-locking mandrel
- Torque: 3 Nm
- Motor power: 675 W
- Rotation speed: 2,800 rpm



**NEW**

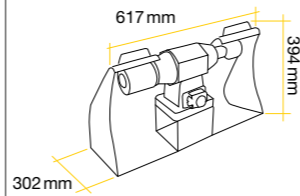
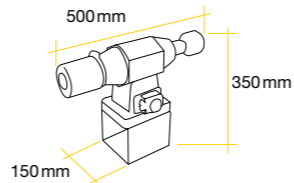

### CARTER OPTION

Dust collection tray (does not require aspiration).  
2 housings available: right and left.

Right Side Ref. PPGTOURG1EVO\_AD Right Side Ref. 619067101  
Left Side Ref. PPGTOURG1EVO\_AG Right Side Ref. 619282101

### RAISER OPTION

Raiser allowing the grinder to be raised to improve the working ergonomics.

Ref. PPGTOURG1EVO\_REHAUS Ref. 617968101

## G2 GRINDER

Ref. PPGPONCECAR Ref. 995 94701

- Double head.
- Expanding wheel.
- Shielding.
- Torque 1.8 Nm.
- Motor power: 600 W.
- Power consumption: 600 W.
- Speed of rotation: 2850 r.p.m.



Vacuum cleaner attachment point on back of grinder

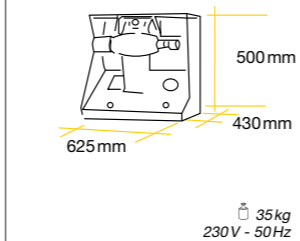

## G3 GRINDER

Ref. PPGUNIPON Ref. 995 94901

- Double head.
- Expanding wheel.
- Shielding.
- Turbine suction.
- Torque 1.9 Nm.
- Motor power: 600 W.
- Power consumption: 1000 W.
- Speed of rotation: 2850 r.p.m.

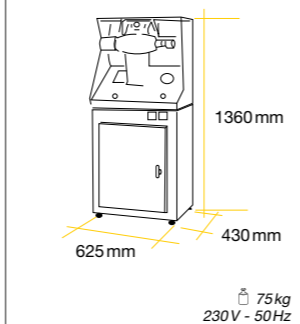

## ACCESSORIES

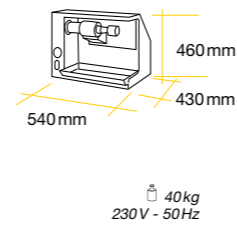

## G4 GRINDER

Ref. PPGTOURG4EVOLUTION Ref. 37257501

- Expanding wheel.
- Shielding.
- Silent.
- Torque 2 Nm.
- Motor power: 550 W.
- Power consumption: 550 W.
- Speed of rotation: 3000 r.p.m.



	Grinding power (Nm)	Ergonomics		Maintenance	Insole finishing	Padding adjustment	Heel Stab adjustment	Liner /boot grinding	Comments
		Space	Dust management						
<b>G1 evo grinder</b>	3	Ultra-compact	Easy cleaning carter	Regular cleaning	●	●	●	●	The ideal tool for introducing boot fitting to your business when you have minimal space available in the workshop
<b>G2 grinder</b>	1.8	Compact	Open-case frame	Localized cleaning	●	●	●	●	This grinder deals effectively with dust, allowing you to work efficiently on insoles. Can be combined with an industrial vacuum cleaner
<b>G3 grinder</b>	1.8	Totem pole structure	Vacuum system	Localized cleaning	●	●	●	●	G2 vacuum system upgrade reduces cleaning times for increased efficiency
<b>Gravity 600</b>	1.8	Compact	Closed-case frame	Easy by design	●	●	●	●	A brand new Sidas product - a perfect combination of performance, appearance and dust management. Can be fitted with a structure to adjust grinder height
<b>G4 grinder</b>	2	Compact	Open-case frame	Localized cleaning	●	●	●	●	The grinder for you if your bootfitting creativity has no limits. Can be combined with an industrial vacuum cleaner

### Accessories kit Grinder G1

Ref. PXACC\_PONSEU Ref. 606419101

- A pair of safety goggles.
- A block to clean the grinding belts.
- 1 grinding belt.
- 2 polishing belts

### Accessories kit: Grinder G2, G3, G4, Gravity 600

Ref. PXACC\_TOURET Ref. 606422101

- A pair of safety goggles.
- 2 blocks to clean the grinding belts.
- 2 grinding belts.
- 2 polishing wheels.
- 1 sanding wheel.





# INNERBOOTS

Experience the ideal fit



# INNERBOOTS PU INNERBOOTS

## PU CLASSIC COMFORT

Ref. CCHPUCLACOMF

Ref. 309527000

The PU Classic Comfort boot liner is a premium customization solution for a perfect fit and optimum comfort. The micro fur interior provides softness and warmth and ensures easy foot entry. The new upper cuff structure provides a better torsion-comfort ratio. Skiers will find this boot liner comfortable and attractive, while boot fitters will find it both safe, and easy to inject.

### SIZES C-L

1. Pullstraps: Easy foot entry
2. Pu carbon structure: Flexibility & design
3. Micro fur interior: Softness, warmth & easy foot entry
4. Pre-shaped injection pocket: Initial fit & ease of injection
5. Laces: Good foot support



Issued with Ready-to-fit tongue

## PU CLASSIC RACE

Ref. CCHPUCLARACE

Ref. 311930000

The Classic Race PU innerboot is exclusively designed for narrow ski boots. Uncompromising, it is ideal for skiers looking for ultimate precision. With its fine pocket structure, the innerboot perfectly fits the foot and the shell after injection. Every detail is meticulously thought out to avoid hard spots. Fitted with an injectable tongue (by PU gun), the innerboot guarantees optimal and personalised shin comfort.

### SIZES C - L

1. Pullstraps: Easy foot entry
2. Pu carbon structure: Flexibility & design
3. Textile interior: Precision & easy foot entry
4. Thin injection pocket: Precise injection
5. Strap holding
6. Injected tongue



Issued with PU foam tongue

## PU TRANSFOAM FLEX

Ref. CCHPUTRAFLEX

Ref. 307886

This 'Flex' material has the same properties as Transfoam but offers more flexibility, stretchability and comfort. For technical skiers looking for a simpler injection process and a tolerant liner that doesn't affect shell rigidity. Transfoam technology features sealed bags that reduce leakage.



## PU CLASSIC FLEX W

Ref. CCHPUCLFLW15

Ref. 380462

The Classic Flex Women boot liner, developed for the needs of female skiers, combines comfort and precision. The form and the materials used (e.g. micro-fur) ensure softness, flexibility, elasticity and overall comfort. The design of these boot liners is ideal for the Sidas shells created especially for female skiers.



## CENTRAL HIGH V3

Ref. CCHFCENTHIV3

Ref. 380460

Fully thermoformable. Provides maximum comfort and precision. Designed for alpine skiing and ski touring (high boots with 4 buckles). With its internal design in black micro-fur the boot liner offers skiers softness and comfort.



## CENTRAL WOMEN

Ref. CCHFCENTW15

Ref. 380461

This fully thermoformable boot liner is designed for female skiers requiring comfort and warmth. This boot liner is also available in the warming version.



Pack of 10.

ULTRALON



Issued with Ready-to-fit tongue slim

ULTRALON



Issued with Ready-to-fit tongue

# INNERBOOTS THERMOFORMABLE INNERBOOTS

## CENTRAL REMOVABLE TONGUE SLIM (CRT SLIM)

Ref. CCHCFTHERCRTSL19

Ref. 31643100

The finest thermoformable liner. 100% thermoformable, this liner is designed for alpine or touring ski boots with a low fitting volume. Designed with the same technology as the CRT, it is distinguished by its finesse and lightness. The removable flap is thermoformable and can also be replaced by an injectable Sidas flap or a Heat Ready heated flap.

### SIZES: D-K

1. Merry mesh lining: Comfort, lightness, low thickness
2. Collar joint: High flexibility, follows the rolling out of the foot as you walk
3. 3 lateral EVA thicknesses: Precision and comfort + heel support
4. Thin removable flap: For maximum precision



## CENTRAL REMOVABLE TONGUE (CRT)

Ref. CCHCFTHERCRT18

Ref. 314194000

100% thermoformable, this liner is designed for alpine skiing and cross-country skiing. The result of 2 years of development with the best bootfitters, its internal structure, with variable thicknesses, guarantees comfort and precision after moulding. The removable flap is thermoformable and can also be replaced by an injectable Sidas flap or a Heat ready heated flap

### SIZES D - K

1. Micro-fur upper lining: Maximum comfort
2. Merry mesh lower lining: For greater precision
3. Upper cuff opening: Flexibility
4. 3 EVA side width: Precision and comfort & heel support
5. Removable tongue: For optimal precision





**TONGUE HEAT READY** powered by Therm-ic

Ref. CCHDCLARTFHR19

Ref. 316588000

Adjustable heated flap made using Therm-ic technology. Designed for skiers who suffer from cold feet who want to combine comfort and technology with a 100% customised heated liner. Invisible heating element integrated into the front of the liner ensuring optimal warmth for the foot. Works with C-pack Therm-ic batteries (sold separately)



**READY-TO-FIT TONGUE SLIM**

Ref. CCHDCLARTFSL19

Ref. 316589000

The fine and adjustable liner is designed for alpine or touring ski boots with a low fitting volume. Its design offers greater precision and adapts perfectly to the foot.



**READY-TO-FIT TONGUE V2**

Ref. CCHDCLARTV2

Ref. 372492

A ready-to-fit tongue V2, with a highly curved shape to fit snugly against the foot and enable maximum transmission power, and a unique design to provide a perfect progressive flex.



**PU FOAM TONGUE**

Ref. CCHACFTONG17

Ref. 312025000

The adaptable tongue is very curved to fit perfectly to the foot and allow maximum power of transmission. Its unique design provides flexion perfect progressive.



**PU  
INNERBOOTS  
PROCESS**



**THERMO  
INNERBOOTS  
PROCESS**



**FOAM PODIUM**

Ref. COUCHPOD  
Ref. KC0111

The ultimate foaming station with adjustable handles, 2 drawers, and a rotation device to facilitate the foaming process.



**MINI FOAM PODIUM**

Ref. COUCHPOD2T  
Ref. 866233

Podium to foam PU liners with drawers.



**TONGUE PU KIT**

Ref. CCHACDOSTON17  
Ref. 312026101

Injection kit for PU tongue (technology with PU gun).



**TONGUE PU GUN**

Ref. CCHACPUGUN  
Ref. 312028101

Gun for injecting PU tongues.



**FOAM TONGUE STRAP**

Ref. CCHACFTSTRAP  
Ref. 99530901

The strap enables you to tighten the foam tongue against the shin, in order to control the foam flow.



**3D TOE CAPS**

Ref. (3 sizes) (T1 / TM / T2)  
CCHACTOECAP3DX3  
381879



**PU DOWN-GRADING KIT**

Ref. (box of 10) CCHACPUGRDKIT  
Ref. (box of 10) 36007401

A dropper for obtaining a smaller dose of Isocyanate for a more flexible foam.



**ADHESIVE PAD**

Ref. CCHACCAL / KC1225  
Ref. (Adhesive pads 5-15)  
CCHACADH5-15 / 310969101  
Ref. (Adhesive pads 2-50)  
CCHACADH2-50 / 309564101  
Packs ok 10



**ADHESIVE ROLL**

Ref. (Reinforced) CCHACS50  
Ref. (Reinforced) KC1208  
Ref. (Soft) CCHACS15  
Ref. (Soft) KC2032



**LYCRA SOCKS**

Ref. CCHACCLY  
Ref. KC1440



**CONFOR'FIT OVEN**

Ref. (220V) COUCHFOU2 / 10882001  
Ref. (110V) COUCHFOU1 / 866018

The Confor'fit oven is designed for heating thermo-moldable liners.

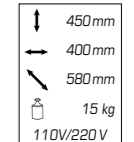



SOCKS

SOCKS



# SOCKS

Your second skin



# UNIQUE SOCK DESIGN BASED ON 300,000 FEET FOR A PERFECT FIT BETWEEN YOUR FEET AND YOUR SHOES!

## Our SYNERGY FIT™ range:

- "PURE SOCKS" with no stitching or reinforcement around the foot for a perfect fit with your sole and shoe. For more sensitivity, more precision and more enjoyment!
- meets various needs dependent on your activity. For skiing, the main needs are: warmth, protection and compression.
- composed of several thicknesses to get the perfect fit in the shoe.



SKI



THICKNESSES



GUARANTEE FIT

# THE SYNERGY FIT PURE SOCKS

## MARKETING TOOLS

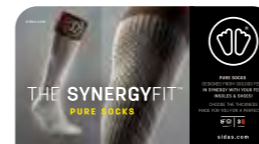

### FACING SYNERGY FIT

Ref. EN-FR: CMKSOFACINSYFIT19  
Ref. EN-FR: 316661101



### POP SYNERGY FIT

Ref. EN-FR: CMKSOPPOPSYFIT19  
Ref. EN-FR: 316662101

### COMPOSITION LV

Natural fibres  
• 20 % Merino

### Synthetic fibres

- 59 % Polyamide
- 19 % Acrylic
- 2 % Elastane

### COMPOSITION MV

Natural fibres  
• 28 % Merino

### Synthetic fibres

- 43 % Polyamide
- 27 % Acrylic
- 1 % Elastane

### SIZES

- XS 35/36
- S 37/38
- S/M 39/40
- M/L 40/41
- L 42/43
- XL 44/45/46
- XXL 47/48/49

## SOCKS SKI COMFORT

Ref. Ski Comfort LV socks CSOSKCOMF19\_LV

Ref. Ski Comfort LV socks 316422100

Ref. Ski Comfort MV socks CSOSKCOMF19\_MV

Ref. Ski Comfort MV socks 316422200

### Ski sock that combines warmth and sweat wicking for optimal comfort!

This ski sock is perfect for skiers looking for comfort and warmth. Specially designed to adapt to the anatomical shape of the foot to ensure maximum comfort for the skier so they can enjoy their day to the full. Natural wool combined with technical fibres ensures temperature regulation and effective sweat wicking. The sock is also compressive meaning that it is closer to the foot, ensuring optimal comfort.

2 THICKNESSES LV/MV: Available in low or medium volume to adapt to your foot & shoe fit

OPTIMAL COMFORT: Warmth and softness all day

KNEE LENGTH: Adapted to ski boots

HYBRID COMPOSITION: Regulates temperature & wicks away perspiration effectively

MODERATE FIT 10-15 mmHg: Fits the foot shape



WARMTH  
Chaleur



2  
THICKNESSES  
Epaisseurs



MODERATE FIT  
Tension moyenne



### SOCKS SKI MERINO

- Ref. Ski Merinos LV socks CSOSKMER19\_LV
- Ref. Ski Merinos LV socks 316420100
- Ref. Ski Merinos MV socks CSOSKMER19\_MV
- Ref. Ski Merinos MV socks 316420200
- Ref. Ski Merinos MV Brown CSOSKMERBR20\_MV
- Ref. Ski Merinos MV Brown 319842000

The ski sock is made with a high percentage of merino, providing comfort and warmth during sporting activities, with a very good fit!

Comprising a high percentage of Merino wool, this warm sock is designed for skiers who suffer from cold feet. Natural wool combined with technical fibres ensures temperature regulation and effective sweat wicking for optimal comfort. This compressive sock also gives you greater sensation and precision when you practise your sport.

2 THICKNESSES LV/MV: Available in low or medium volume to adapt to your foot & shoe fit

MERINO WOOL: Warmth, odors & humidity absorption

KNEE LENGTH: Adapted to ski boots

HYBRID COMPOSITION: Regulates temperature & wicks away perspiration effectively

FIRM FIT 15-20 mmHg: Precision & sensation



MERINO WOOL  
Laine Mérinos



WARMTH  
Chaleur



THICKNESSES  
Epaisseurs

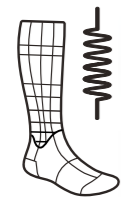

FIRM FIT  
Forte tension

NEW

#### HIGH BLACK FOOT 50 CM

Ref. CMKKFPSFAIM20\_50  
Ref. 319206101



#### MID BLACK FOOT 40 CM

Ref. CMKKFPSFAIM20\_40  
Ref. 319205101



#### LOW BLACK FOOT 30 CM

Ref. CMKKFPSFAIM20\_30  
Ref. 319204101

COMPOSITION LV  
Natural fibres  
• 39 % Merino

Synthetic fibres  
• 59 % Polyamide  
• 2 % Elastane

COMPOSITION MV  
Natural fibres  
• 52 % Merino

Synthetic fibres  
• 46 % Polyamide  
• 2 % Elastane

#### SIZES

- XS 35/36
- S 37/38
- S/M 39/40
- M/L 40/41
- L 42/43
- XL 44/45/46
- XXL 47/48/49

### SOCKS SKI PROTECT

- Ref. Ski Protect LV socks CSOSKPROT19\_LV
- Ref. Ski Protect LV socks 316421100
- Ref. Ski Protect MV socks CSOSKPROT19\_MV
- Ref. Ski Protect MV socks 316421200

The sock provides warmth and protection, enabling you to enjoy each day's skiing to the full!

This protective sock is designed for skiers who want to cushion shocks and eliminate shin pain. With tibial foam protection, it prevents pain and cushions shocks. Natural wool combined with technical fibres ensure temperature regulation and effective sweat wicking. The sock is also compressive meaning that it closer to the foot, ensuring optimal comfort.

2 THICKNESSES LV/MV: Available in low or medium volume to adapt to your foot & shoe fit

SHIN PROTECTION: Prevents shin pain & absorbs shocks

KNEE LENGTH: Adapted to ski boots

HYBRID COMPOSITION: Regulates temperature & wicks away perspiration effectively

MODERATE FIT 10-15 mmHg: Fits the feet shape

COMPOSITION LV  
Natural fibres  
• 25 % Merino

Synthetic fibres  
• 57 % Polyamide  
• 16 % Polypropylene  
• 2 % Elastane

COMPOSITION MV  
Natural fibres  
• 34 % Merino

Synthetic fibres  
• 42 % Polyamide  
• 22 % Polypropylene  
• 2 % Elastane

#### SIZES

- XS 35/36
- S 37/38
- S/M 39/40
- M/L 40/41
- L 42/43
- XL 44/45/46
- XXL 47/48/49



SHIN PROTECTION  
Protection tibiale



WARMTH  
Chaleur



THICKNESSES  
Epaisseurs



MODERATE FIT  
Tension moyenne



### SOCKS SKI ULTRAFIT

Ref. Ski Ultrafit ULV socks CSOSKULTH19_ULV	Ref. Ski Ultrafit ULV socks 316429100
Ref. Ski Ultrafit LV socks CSOSKULTH19_LV	Ref. Ski Ultrafit LV socks 316429200

Very thin and compressive sock, designed for skiers looking for greater performance and sensations.

Knitted with more than 200 needles, this ultra-fine sock ensures the direct transmission of information between the foot and the shoe. This second skin effect will make you feel as if you are skiing barefoot. The high compression offers greater precision and sensations, and aids recovery. Natural wool combined with technical fibres ensures temperature regulation and effective sweat wicking.

- SECOND SKIN EFFECT : Ultra-thin sock ideal for skiers looking for enhanced sensations
- 2 THICKNESSES ULV/LV: Available in ultra low or low volume to adapt to your foot & shoe fit
- KNEE LENGTH: Adapted to ski boots
- HYBRID COMPOSITION: Regulates temperature & wicks away perspiration effectively
- COMPRESSION FIT 20-30 mmHg: Performances & recovery.

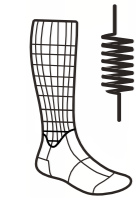

COMPRESSION  
Compression



COMFORT  
Confort



THICKNESSES  
Epaisseurs



PRECISION  
Précision



**COMPOSITION ULV**  
Natural fibres  
• 22 % Merino  
• 10 % Silk  
Synthetic fibres  
• 66 % Polyamide  
• 2 % Elastane

**COMPOSITION LV**  
Natural fibres  
• 32 % Merino  
• 10 % Silk  
Synthetic fibres  
• 48 % Polyamide  
• 10 % Elastane

**SIZES**  
XS 35/36  
S 37/38  
S/M 39/40  
M/L 40/41  
L 42/43  
XL 44/45/46  
XXL 47/48/49

### BATTERY NEO S

Ref. HESONEOS17  
Ref. 511939101



<b>LOW</b>	6h to 8h
<b>MEDIUM</b>	3h to 4h
<b>MAX</b>	2h to 3h

### BATTERY PRO S

Ref. HESOPROS17  
Ref. 511938101



<b>LOW</b>	12h to 16h
<b>MEDIUM</b>	6.5h to 7.5h
<b>MAX</b>	4h to 5.5h

**COMPOSITION LV**  
Natural fibres  
• 25 % Merino  
Synthetic fibres  
• 57 % Polyamide  
• 16 % Polypropylene  
• 2 % Elastane

**COMPOSITION MV**  
Natural fibres  
• 34 % Merino  
Synthetic fibress  
• 42 % Polyamide  
• 22 % Polypropylene  
• 2 % Elastane

**SIZES**  
XS 35/36  
S 37/38  
S/M 39/40  
M/L 40/41  
L 42/43  
XL 44/45/46  
XXL 47/48/49

### SOCKS SKI HEAT

Ref. Ski Heat LV socks CSOSKHEAT19_LV	Ref. Ski Ultrafit ULV socks 316428100
Ref. Ski Heat MV socks CSOSKHEAT19_MV	Ref. Ski Heat MV socks 316428200

Powered heat socks, provide optimal comfort and warmth during your sporting activities, with a very good fit!

This heated sock is designed for skiers who suffer from cold feet. An invisible heating element on the outside of the sock gives off a soft and constant heat under the front of the foot for optimal comfort. Natural wool combined with technical fibres ensure temperature regulation and effective sweat wicking. This compressive sock also gives you greater sensation and precision when you practise your sport.

- 2 THICKNESSES LV/MV: Available in low or medium volume to adapt to your foot & shoe fit
- HEATING ELEMENTS: Distributes gentle, constant and uniform warmth
- KNEE LENGTH: Adapted to ski boots
- HYBRID COMPOSITION: Regulates temperature & wicks away perspiration effectively
- FIRM FIT 15-20 mmHg: Greater precision & sensation



HEATING  
Chauffant



COMFORT  
Confort



THICKNESSES  
Epaisseurs

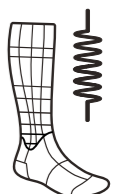

FIRM FIT  
Forte tension



FITTING SERVICES

FITTING SERVICES



# FITTING SERVICES

Making the liner, insoles & shell yours





# FITTING SERVICES MAPPING TOOLS

## STRETCH THE SHELL TOOLS

CROCO TWIN	Ref. COUCHCROTWIN20 Ref. 319783101	 <b>NEW</b>
YETI V2	Ref. COUCHYETI14 Ref. 37249401	

## STRETCH THE SHELL TIPS

VARIABLE ARCH	Ref. COUCHARCH14 Ref. 37249501	
STRETCHING RING	Ref. COUCHRING14 Ref. 37249601	
MET BALL	Ref. COUCHMETBALL14 Ref. 37248701	
ANKLE BALL	Ref. COUCHANKLE14 Ref. 37249801	
MET OGIVE	Ref. COUCHMETOGIV14 Ref. 37249901	
MET OGIVE XL	Ref. COUCHMETOGXL20 Ref. 319784101	 <b>NEW</b>
WOOD MET 1	Ref. COUCHWOODMET1 Ref. 37250001	
WOOD MET 2	Ref. COUCHWOODMET1 Ref. 37250102	
JUMBO/JUMBO+	Ref. COUCHJ-J Ref. KC0104	
OVAL TIP 67	Ref. COUAOYOG Ref. 37257601	
ROUND TIP 50	Ref. COUAOYEG Ref. 37257701	
ROUND TIP 35	Ref. COUAOYEP Ref. 37257801	
WOOD TIP1	Ref. COUCHWOODTIP1 Ref. 37250201	
WOOD TIP2	Ref. COUCHWOODTIP2 Ref. 37250301	
WOOD HEEL	Ref. COUCHWOODHEEL Ref. 37250401	

## ACCESSORIES

CROCO LIGHT FIX	Ref. COUCHFIXCROCLHT Ref. 37250501	
CROCO TWIN FIX	Ref. COUCHFIXCROTWIN20 Ref. 319785101	 <b>NEW</b>
SYMETRIC CONNECTOR	Ref. COUCHSYMCON Ref. 37250601	
EXTENSION 28 MM	Ref. COUAOYPR Ref. 37257901	
EXTENSION 40 MM	Ref. COUAOYMR Ref. 37258001	
EXTENSION 75 MM	Ref. COUAOYGR Ref. 37258101	
WASHER 3MM	Ref. COUAOYRO Ref. 37258201	
STABILITY BLOCK	Ref. COUCHPONT13 Ref. 37258301	

## REDET - UNIREDET - TOOLS

CROCO	Ref. COUCHCROCO14 Ref. 37250701	
-------	------------------------------------	---

## OPEN THE SHELL

JACK	Ref. COUCHJACK Ref. KC0108	
BOOT HOLDER - 1	Ref. COUCHSABO Ref. KC0105	 <b>1</b>
TOOL CLAMP - 2	Ref. COUCHFIXE Ref. KC0106	 <b>2</b>
BOOT SPREADER 360	With fixation: Ref. COUCHSPREADFIX Ref. 37250801 Without fixation: Ref. COUCHSPREAD Ref. 37250901	

## HEAT THE SHELL

NESTOR V3	Ref. CMALBBL30NES Ref. 36009901	
-----------	------------------------------------	---

# FITTING SERVICES STRETCHING



## KIT DEFORM TWIN

Ref. COUCHKIT75TWIN

Ref. 319792101

**NEW**

Experience shows that more than 75% of the reshaping done by bootfitters are due to localised foot pain.

This Kit Deform Twin is the basic kit for stores wishing to start a boot-fitting operation and to offer a quick and efficient service to their customers.



TOOLS	CHARACTERISTICS	ADVANTAGES	BENEFITS
<b>1</b> CROCO TWIN	- 10mm steel structure - 45° curvature - Deformation measuring system - Removable tool support heads	Shell reshaping tool that allows the bootfitter to access all parts of the shoes and also to measure the size of the reshaping carried out. Its symmetrical construction allows a single tool to be used for the best results for both right and left shoes.	- The precision of the alignment of the tool under Stress is guaranteed - Allows for precise reshaping of the forward parts of the foot (M1 and M5) - The reshaping work is carried out with precision - Makes it possible to work on the right and left areas with a single tool - Easy and effortless reshaping
<b>2</b> VARIABLE ARCH	- Double shaft - Plates on ball join - 190 mm serif	- Possibility to have 2 push axis - Provides support on differently shaped surfaces - Big space between the push axis and the support surface	- Allows very extensive forefoot deformations - Provides a stable and homogeneous support - Avoids damaging the shell during deformation
<b>3</b> STRETCHING RING	- Diam: 137 mm	- Large support far from push axis	- Doesn't mark the shell
<b>4</b> METAL CONNECTORS	- Aluminium structure - Mounted with screw	- Maintains the heat - Easy to mount and dismount	- Give an inside heating of the deformation zone, creating a more precise and quick deformation - Time gain when changing the tips, and keep the rotation of the tips

## KIT DEFORM 75 +

Ref. COUCHKIT75P

Ref. 37251301

This kit is designed to complement the Deform 75 kit. It is used for localised shaping of wider boot shells. Used together with the Deform 75 kit, it provides an enhanced solution to customers' localised foot pain problems.

- 1** WOOD MET 1
- 2** WOOD MET 2
- 3** EXTENSION 28 + SYMETRIC CONNECTOR



## KIT DEFORM YETI

Ref. COUCHKIT75P

Ref. 37251401

Used and approved by boot fitters for more than 10 years, the Yeti and Yeti+ kits have now been combined to create the Deform Yeti kit.

It is suitable for all generalised boot shaping requirements. Designed to complement the Deform 75 and Deform 75+ kits, it is suitable for all boot shell-shaping requirements.





# FITTING SERVICES ANALYSE AND OPEN

## BOOTFITTING SERVICE

Ref. CMALBBFSERV15

Ref. 38046701

The Bootfitting Service is a working and storage unit that allows you to promote the boot-fitting service in your store. It consists of a work table, a drawer, a storage space for the oven and a space to display messages about your store and boot-fitting service.

The Bootfitting Service is for use with Sidas tools such as the Kit Deform 75 or the Kit Deform Yeti.

Unit only - tools to be ordered separately.

Overall dimensions: 86 x 63 cm

Working surface dimensions: 75 x 54 cm



MADE IN FRANCE



## BOOT SPREADER 360

Ref. without accessories  
COUCHSPRE360  
319786101

Ref. Kit  
COUCHKITSPRE360  
319790101

NEW

Makes the analysis easier. It is the essential in-store tool to check that the shoe is suitable for the foot. Its ability to open wide and rotate through 360° make working with it safer and simpler.

- Aluminium profile structure
- Enhanced steel handles
- Universal shell attachment system

Dimensions: 54 x 43 CM



### OPTION



OPTION  
LED LIGHT

Ref. COUCHLEDLIGHT  
Ref. 319788101

Magnetic lamp that can be fixed to the Bootspreader 360, allowing the inside of the shell to be lit for precise and safe work.



OPTION BALL JOIN  
HOLDER 360

Ref. COUCHBALLHOL360  
Ref. 319787101

Fixable ball joint on the work bench allowing the shell to be oriented in any direction.



OPTION WORKBENCH  
ADAPTOR

Ref. COUCHWOBENADAP  
Ref. 319789101

Fixing bracket for the worktop allowing the bootspreader to be offset on the worktable for better ergonomics for the bootfitter.



Working situation



### TONGUE SPOILER COVER

Ref. CCHACIPSCOV16-SPO  
Ref. 309769101  
Pack of 20 units



# FITTING SERVICES ON SOLE & TONGUE SOLUTIONS

## VOLUME REDUCER

Ref. 3MM  
CSEDSRV3  
995942

Ref. 5MM  
CSEDSRV5  
866007

This volume-reducer can be placed under a Sidas insole to reduce the fitting room and provide better foot support inside the boot, for superior precision and comfort.

Available in 3mm thickness (high-density) and 5mm thickness (medium-density). Can be trimmed to ensure a better fit inside the boot.

Sold in boxes of 20 pairs.



3 mm

5 mm

## HEEL LIFT HARD

Ref. 4MM  
CSEACHELLFT16\_HD\_04  
309545201

Ref. 6MM  
CSEACHELLFT16\_HD\_06  
309545202

Heel insert that goes inside the boot to reduce the volume. Sold in packs of 20 pairs.

Heel lift hard 4mm

Heel lift hard 6mm



## HEEL LIFT SOFT

Ref. 6 MM CSEACHELLFT16\_SF\_06

Ref. 6 MM 309545102

Heel insert that goes inside the boot to reduce the volume. Sold in packs of 20 pairs.

HEEL LIFT SOFT 6MM



## TONGUE SPOILER

Ref. CCHACTONGSP016

Ref. 309567101

The tongue spoiler is used to regulate the volume between the shell interior and tongue.

The spoiler is:

- pre-shaped;
- adhesive-coated;
- grindable;
- thermoformable;
- thickness 5 to 10 mm;
- pack of 1 pair.

Available in 1 size





# WORK ON EXISTING LINERS

## ICP • INNERBOOT PADDING SYSTEM

Ref. 10 ROUNDS CCHACICP-ROND 328535	Ref. 10 OVALS CCHACICP-OV 328539	Ref. SCALPEL + 1 BLADE P99SCALPEL 32834001	5 BLADES FOR SCALPEL P99SCALPLAME 32834101
---	--	--	--

A way of modifying boot liners to solve skiers' foot problems!

This system involves cutting sections out of the boot liner in the places that are causing the skier pain and replacing these sections with Innerboot Comfort Padding, making the liner more comfortable and quickly relieving pain. Pre-cut elements in several shapes with a protective top layer included: a fast solution for the bootfitter.

Materials used: padding made from Expertène 220 (PU foam) and Ionmesh top layer: advanced materials for an effective, professional solution.

Grey top layer with Sidas logos.



### ICP KIT

Ref. CCHACICPKIT	Ref. 32833901
------------------	---------------

- 1 Scalpel
- Oval pads: 4s – 6m – 2l
- Oval toplayers: 4s – 6m – 2l
- Round pads: 2s – 4m – 6l
- Round toplayers: 2s – 4m – 6l

## MARKETING TOOLS



### BOOTFITTING POSTER

Ref. CMKPOSB00TF14 37256401
-----------------------------------

Information poster about Sidas' boot-fitting solutions for in-store display.



### BOOTFITTING PRICE SERVICES POSTER

Ref. CMKBOOTFITPR14 37256101
------------------------------------

Boot-fitting prices poster for workshop services.



### ICP PROCESS

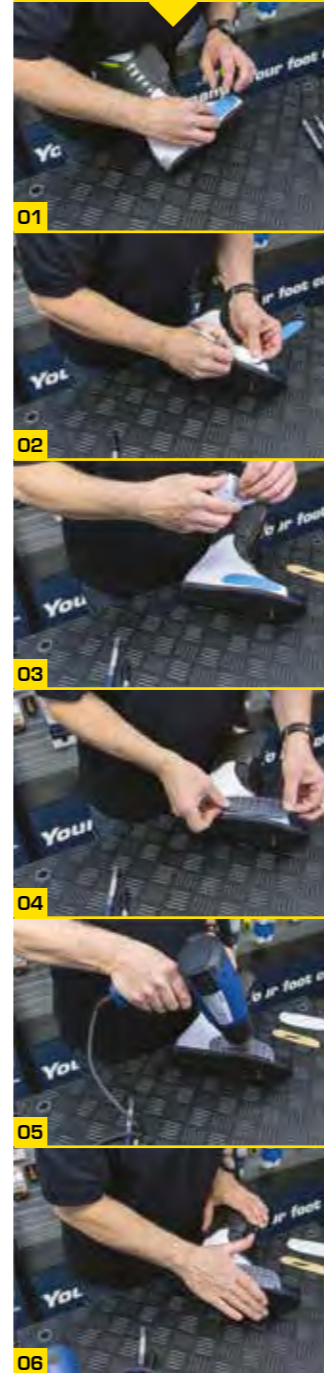

### IPS PROCESS



# WORK ON EXISTING LINERS

## IPS • INNERBOOT PADDING SYSTEM



(PACK OF 10 PCS - ONE SIZE) Ref. IPS C SHAPE CCHACIPS16-C 309557101
--



(PACK OF 20 PCS - ONE SIZE) Ref. IPS C COVER CCHACIPSCOV16-C 309740101
---



(PACK OF 10 PCS - ONE SIZE) Ref. IPS DONNUT SHAPE CCHACIPS16-DON 309562101
---

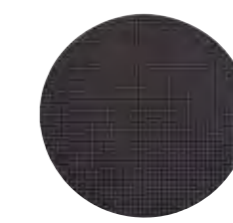

(PACK OF 20 PCS - ONE SIZE) Ref. IPS DONNUT COVER CCHACIPSCOV16-DON 309741101
--



(PACK OF 10 PCS - SIZES: M - L) Ref. IPS V SHAPE CCHACIPS16-V 309561000
--



(PACK OF 20 PCS - ONE SIZE) Ref. IPS V COVER SIZE CCHACIPSCOV16-V 309742101
--

### IPS KIT

Ref. CCHACIPSKIT	Ref. 99658701
------------------	---------------

- 6 Double-taped soft foam sheets
- 4 Double-taped hard foam sheets
- 5 Double-taped resin sheets
- Scissors, pen and templates

### IPS SHEET

Ref. IPS soft foam 25 CCHACIPSOFT 99658801	Ref. IPS hard foam CCHACIPSHARD 99658901
Ref. IPS soft foam 40 CCHACIPSOFT40 309554101	Ref. IPS Resin CCHACIPRESI 99659001
Ref. IPS templates CCHACGAB KC2033	





## CONFOR'FIT OVEN

Ref. 220V COUCHFOU2 10882001	Ref. 110V COUCHFOU1 866018
------------------------------------	----------------------------------

The Confor'fit oven is used to heat thermoformable boot liners (central high, central women, etc.). It is also used to heat ski boots with a thermoplastic shell, including Salomon® models. The Confor'fit oven can be heated to 105°C (variation of + or - 5°C).



↑	450 mm
←	400 mm
↙	580 mm
📦	15 kg
110V/220V	

## HEAT GUN

Ref. COUSESAC	Ref. KC0112
---------------	-------------

High-quality hot-air gun tested and approved for bootfitting operations (localised heating of the inside and outside of the boot shell, reactivating glue and adhesives, etc.).



	Temperature (°C)	Heating process	Mobile	Can be left to run	Associated products						Comments
					Glue & Tape	Fitting elements	CustomFit liners	Fullthermo liners	Small areas of shell	All of shell	
HEAT GUN	90 - 600	local	•		•	•			•		The must-have for any boot fitting business
CONFOR'FIT OVEN	105	interior/exterior		•		•	•	•	•		The only tool that heats both liners and shell at the same time



# FOOT PRODUCTS

Foot care solutions

FOOT PRODUCTS

FOOT PRODUCTS



## SHIN PROTECTORS

Ref. ASKINSHINPROTXL16

Ref. 109555101

Larger shin protectors for maximum comfort. The shin protectors are supplied in pairs and are specially shaped to fit the shin. They effectively relieve pain caused by pressure on the shins from ski boots. Placed underneath the sock, these protectors stay firmly in place throughout any sporting activity.



x 2

Varying-thickness gel: 2 mm at the edges and 4 mm in the middle, for improved protection.

Re-usable.

Hand-washable with household detergent for a better hold.

Supplied in 20s in a paperboard box that also serves as the in-store display unit.

## ANKLE PROTECTORS

Ref. ASKINANKLEPROT16

Ref. 109556101

Silitene™ protectors specially designed to fit round the ankle. They effectively relieve pain caused by the boots pressing against and rubbing the inside and outside of the ankle. Placed underneath the sock, these protectors stay firmly in place throughout any sporting activity.



x 4

Varying-thickness gel: 2 mm at the edges and 4 mm in the middle, for improved protection.

Re-usable.

Hand-washable with household detergent for a better hold.

Supplied in 20s in a paperboard box that also serves as the in-store display unit.

## PROTECTOR SHEET 2MM

Ref. ASKINFOOTPROT14\_02SH

Ref. 36829701

The Silitene™ protection sheet is your best ally when practicing a sporting activity. Apply the protection to on the friction areas to ease the pain for instant comfort. Their biomechanical construction allows for long-lasting protection. Washable. Multi day use.



x 1

Dimensions: 90 x 100 mm

## MARKETING TOOLS



### ON SKIN BOX

On Skin range box that can also be used as a display. All On Skin products are supplied in 20s in this box.

## MARKETING TOOLS



### FOOT PROTECTION WALL POS

FR/EN  
Ref. CFCMKFPWALLPOS\_01  
Ref. 31106210  
EN/DE  
Ref. CFCMKFPWALLPOS\_02  
Ref. 311062102



## GEL TOE CAPS

Ref. ASKINGLTOECA17

Ref. 111050000



x 2

Gel toe caps allow you to enjoy your sport to the full. Used preventively, they avoid nails turning black due to impacts in the shoe. In case of existing pain, they absorb impacts for instant relief. Washable, reusable silicone protectors.

SIZES: S/M (36-40) / L/XL (41-47)

Pack per per

Ajustable length

Delivered in box of 20 or per unit



Sizes Tailles	Big Toe Gros orteil	Middle Toes Orteils moyens	Small Toes Petits orteils
36-39 (EU) 4-6 (US) 3-6 (UK)	S/M	XS	XS
40-46 (EU) 7.5-13 (US) 6.5-12 (UK)	L/XL	S/M	XS



## GEL TOE WRAPS

Ref. ASKINGLTOEWR17

Ref. 111051000



x 4

Gel toe sleeves allow you to enjoy your sport to the full. They ease pain caused by friction between toes and prevent corns and calluses.

SIZES: S/M (36-40) / L/XL (41-47)

Pack per per

Ajustable length

Delivered in box of 20 or per unit



## GEL PLANTAR PROTECTORS

Ref. ASKINGLPLAPR17

Ref. 111049000

Gel plantar protectors allow you to enjoy your sport to the full. Used preventively, they avoid inflammation, burns and blisters. In case of existing pain, they absorb impacts for instant relief.

SIZES: S/M (36-40) / L/XL (41-47)

Pack per per

Anatomical Construction (right foot / left foot).

Delivered in box of 20 or per unit



x 2





# BOOT ACCESSORIES

Enhance your bootwear



# SKI BOOTS TRACTION

Ski boot traction devices allow you to walk confidently and comfortably with your ski boots. Their tapered shape at the tip makes the movement of the foot easier and their asymmetric crampon design makes walking on snow safer.

### SIZE ADJUSTMENT



- Check the length of your ski boot in mm.
- Adjust the ski boot traction device to the corresponding size (round down). The tip of the arrow indicates the size selected.
- Screw in with a Phillips screw-driver.

### FITTING THE DEVICE ON THE SHOE



- Strap on the ski boot traction, starting from the front of the boot, then pull back to adjust it on the heel.
- This product should be stored in a dry place, away from heat and UV sources. It is recommended to check the product every year.

### MARKETING TOOLS



### TRACTION DISPLAY

Ref.(EMPTY) CTRMKCARDISPL16  
 Ref.(EMPTY) 309542101  
 Ref. Full of product (20 walk demi /40 walk) CTRPACKCTDISPL16  
 Ref. Full of product (20 walk demi /40 walk) 309630101

- Paperboard display unit supplied assembled.
- Easy to move around the store.
  - Can accommodate 20 Traction ½ & 40 Traction, or 60 Traction.
  - Two options: Supplied without products. Supplied assembled with a set of products ready for sale.



### COLUMN DISPLAY

Ref. CMKPVTOURDIS15  
 Ref. 301216101

The column display is a rotating display stand featuring:

- 8 perforated sides
- 5 castors, 2 of which have brakes
- 1 platform for attaching a demonstration foot.

Dimensions: 180 x 55 cm.

### SKI TRACTIONS

Ref. CTRSKIBOOT17

Ref 311573101

Makes it easy to walk with your ski boots, and protects the outer sole of your shoe. Available in 4 colours

1. Flexible and resistant rubber
2. Inner frame for better grip on your shoes
3. One size adjustable length
4. Small spikes for more grip



SKI BOOT TRACTION BLUE

Ref. CTRSKIBOOTBLU19

Ref. 3661267158995



SKI BOOT TRACTION GREEN

Ref. CTRSKIBOOTGRE19

Ref. 3661267159008



SKI BOOT TRACTION YELLOW

Ref. CTRSKIBOOTYEL19

Ref. 3661267155130





# WALK TRACTION

## GRIP SNOW AND ICE

- Anatomically constructed to facilitate the forward flexing movement of each foot (right and left).
- End studs for superior grip.
- Wider stud base for long-lasting hold.
- Thick, hard-wearing rubber, as used in the motor industry, for a better hold on the foot.
- Shaped at the heel for a better fit.
- Stainless steel stud tips.
- Textured interior webbing for improved grip onto footwear.
- PPE (Personal Protection Equipment)-certified by the CTC.
- Each pair comes with two spare studs.



### MARKETING TOOLS



#### TRACTION SMALL DISPLAY

Ref. CTRMKSMLDISPL16  
Ref. 309541101  
A slim display unit that you can place behind the checkout or for cross merchandising in the footwear department. It can accommodate 4 Traction products.

### ACCESSORIES



#### SMALL BLACK POCKET BAG

Ref. ASACBLKPOCKBAG16  
Ref. 109565101  
Pack of 10.



#### SPARE SPIKES

Ref. CTRSPSPIKES16  
Ref. 309533101  
x 30.

### WALK TRACTION

Ref. CTRWALK16

Ref. 309532000

The Walk Traction system is the best way to stay safe when walking on snow and frozen ground.

Anatomically constructed to facilitate the forward flexing movement of each foot

Easy to put on

4 sizes for a perfect fit.

SIZES: S - M - L - XL



### WALK TRACTION 1/2

Ref. CTRWALKHALF16

Ref. 309531101

The Walk Traction 1/2 system is the best way to stay safe when walking on snow and frozen ground.

Small grip for city shoes.

Easy to put on.

1 Size.





## VENTILATION



### DRYFLOW UV

Ref. DRYFLOW UV EUR HEDRFLOUVEU19 516579101	Ref. DRYFLOW UV UK HEDRFLOUVUK19 516581101	Ref. DRYFLOW UV US HEDRFLOUVUS19 516582101
---	--	--

The DRYFLOW UV dries and purifies wet boots. Quick and effective for all types of boots. Equipped with ultraviolet lamps, the DRYFLOW UV dries, heats, and cleans all shoe types. Easy & compact storage : Adjustable length



### DRYFLOW MINI

Ref. HEDRFLMINUSB20	Ref. 519782101
---------------------	----------------



The Dryflow Mini thoroughly dries out boots in just a few hours. Its ventilation system and UV lamps allow for fast, effective drying for all types of boots. The included timer automatically controls drying time. Compact and lightweight, it is easy to both transport and store. The USB power supply is compatible with all chargers with a USB port (not supplied).

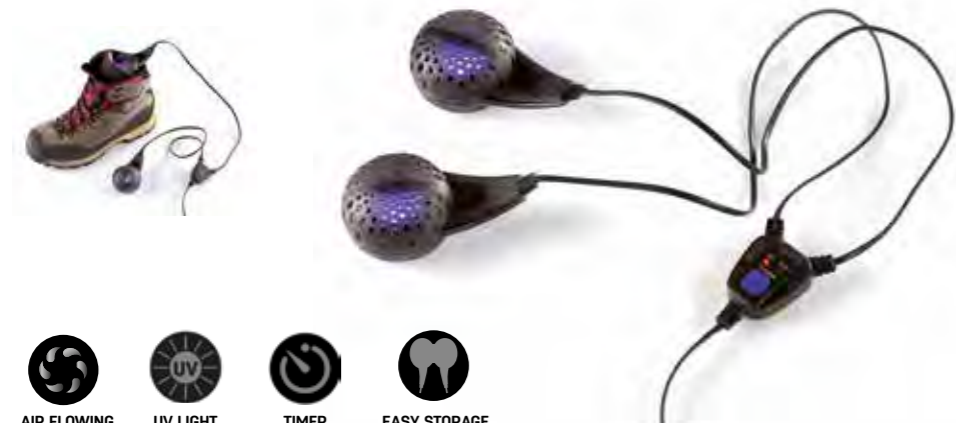

## NATURAL



### DRYER BAG CEDAR WOOD

Ref. CSHACDRYBAWOOD19	Ref. 315502101
-----------------------	----------------

The Dryer Bag Cedar Wood naturally dries all types of damp shoes.

- Absorbs moisture from your shoes 4 times faster than air-drying
- Eliminates odours thanks to its anti-fungal process.
- Made using 100% natural cedar wood and a polyester fabric.
- Reusable and durable product.



#### DISPLAY DRYER

Ref Full. CSHPACKDRYDISFUL20  
Ref. 319846101  
Ref Empty. CSHMKDRYDISP20  
Ref Empty 319845101

Max capacity: 87 packs  
Cardboard display stand:  
width: 540mm and height: 1400mm  
without the header  
Easy to move around in store  
Two options available:  
- delivered without products  
- delivered assembled with a set of  
retail ready products  
Included: 50 Cedar Wood dryer bags,  
25 Dryflow Mini and 12 Dryflow UV.



## VORTEX



### DRYWARMER PRO USB

Ref. DRYWARMER PRO USB HEDRWPROUSB18 514334101
--

Combines drying with sanitising. With the Drywarmer PRO USB, your shoes dry faster. The Vortex effect optimises the circulation of warm air in your boots and reduces the drying time.

The Drywarmer PRO USB is also equipped with an ultraviolet light providing a sanitising, anti-bacterial action. It is also equipped with a timer to programme the drying time of your shoes. The ergonomic shape makes it possible to heat and dry all types of shoes and gloves. The USB socket allows for charging via power adapters equipped with a USB socket (not provided), via wall sockets equipped with USB ports, and via your car.



### DRYWARMER NEO USB

Ref. HEDRWNEOUSB18	Ref. 514333101
--------------------	----------------

#### Shoe Drying System

With the Drywarmer NEO USB, your shoes dry faster. The Vortex effect optimises the circulation of warm air in your boots and reduces the drying time. The ergonomic shape makes it possible to heat and dry all types of shoes and gloves.

The USB socket allows for charging via power adapters equipped with a USB socket (not provided), via wall sockets equipped with USB ports, and via your car.



## POWER STRAP

Ref. Powerstrap men* CCHACBOOSIDM15 309520101
---

The Sidas Booster™ Strap is an essential accessory for improving ski boot performance. When used correctly, it ensures excellent control of the skis, improves comfort and helps prevent shin pain. It eliminates empty space between the shin and the ski boot tongue.



\*Not to be sold in North America (USA and Canada)



The Sidas Booster™ Straps are supplied with 4 screws and 4 grip inserts.



## BOOT BAG BLUE- NYLON

Ref. ASACSKIBAGBL17

Ref. 111792101

Ski boot bag made of soft nylon, allowing easy insertion of the boots.



Dimensions: 40 x 42.5 X 24 cm

Composition: 600 d coated polyester and nylon

Reinforcements: 4 plastic reinforcements on the underside + moisture-wicking

## BOOT BAG BLACK

Ref. ASACSKIBOOTBK15

Ref. 38046901

The Boot Bag Black is an ultra-light, water and dirt-resistant boot bag, reinforced to protect the contents.

The bag opens at the top to allow easier access to gear. The side pocket offers practical storage. The shoulder strap has been reinforced for added comfort when carrying.

The bag is easy to carry thanks to its shoulder strap that can be adjusted to each different person.



Dimensions: 40 x 42.5 X 24 cm

Composition: 600 d coated polyester and nylon

## BOOT BAG MOUNTAIN

Ref. ASACSKIBAGMOUNT17

Ref. 111899101

The Mountain Boot Bag is a lightweight and sturdy ski boot bag. Its coated fabric is water-resistant and dirt-resistant; its numerous reinforcements protect the contents of the bag and increase its durability.

Its central opening allows easier access to the equipment.



Dimensions: 40 x 42.5 X 24 cm

Composition: 600 d coated polyester and nylon

Reinforcements: 4 plastic reinforcements on the underside + moisture-wicking



## BOOT BAG WOMEN

Ref. ASACSKIBOOTW15

Ref. 38046801

The Boot Bag Women is an ultra-light, water and dirt-resistant boot bag, reinforced to protect the contents.

The bag opens at the top to allow easier access to gear. The side pocket offers practical storage. The shoulder strap has been reinforced for added comfort when carrying.

The bag is easy to carry thanks to its shoulder strap that can be adjusted to each different person.



Dimensions: 40 x 42.5 x 24 cm

Composition: 600 D coated polyester and nylon

## NYLON SHOE BAG BLACK

Ref. ASACOUTDSHOE17

Ref. 110900101

The Sidas Nylon Shoe Bag is a small ultra-light bag for one pair of cross-country skiing shoes. It is made of a water-resistant and dirt-resistant fabric to protect the bag's contents perfectly.



Soft bag, 1 front pocket with zipper, 4 plastic stays under the bag

Dimensions: 33 x 25 x 22 cm

Composition: nylon

## LIGHT SHOE BAG

Ref. Blue  
ASACLGTSHOEBL17  
111048101

Ref. Yellow  
ASACLGTSHOEYE17  
11651101

The Sidas Small Sport Shoe Bag is lightweight, easy to carry and can hold a pair of shoes. This small promotional bag can make a lovely gift for your customers (sold in packs of 10).



Format: 50 x 42 cm (yellow) / 40 x 38 cm (blue)

Composition: nylon

## POCKET BAG

Ref. ASACBLKPOCKBAG16

Ref. 109565101

The Sidas Pocket Bag is a small, ultra lightweight bag. It is made from water- and dirt-resistant fabric.





# MARKETING & COMMUNICATION



## SIDAS TOOLS



### SMALL STICKERS - PACK OF 10

CMKSTISMAL12 32953701  
Dimensions : 7 cm x 2.5 cm

### BIG STICKERS - PACK OF 10

CMKSTISBIG12 329538



### SIDAS CUBE

CMKSIDASCUBE12 35476601  
Dimensions : 47 cm x 47 cm



### SHOP WINDOW STICKER

CMKSTIWIND12 32697601

Sticker specially designed for shop windows.  
Dimensions : 20 cm x 11 cm



### SIDAS CUBE

CMKSIDASBCUBE16 35476601  
Dimensions : 40 cm x 40 cm

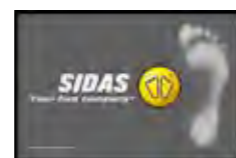

### CARPET

CMKPVTAPlS12 32698301

Dimensions : 80 cm x 60 cm



### CARPET CORNER

CMKPVTAPlSGF 11141101

Dimensions : 200 cm x 200 cm



### SIDAS BOOTH

CMKSIDASBOOTH12 35476801

Dimensions : 2.25 m x 2.25 m



### SIDAS BANNER

CMKSIDASBANNER12 35476701

Dimensions : 80 cm x 2 m



### SIDAS BOOTFITTING CUBE

CMKSIDASBFCUBE15 380 48401

Dimensions : 40 cm x 40 cm



### STICKER VITRINE "CERTIFIED BOOTFITTER"

CMKSTIWINDBF 32834201

«Certified Bootfitter» window sticker  
Dimensions : 21 x 12 cm



### SHOE STICKERS - PACK OF 20

CMKSTISHOE14 36833501

Dimensions : 1.5 cm x 1.5 cm

### FLAME FLAMME SIDAS 18- PIED

315168101 CMKPVFLAMSID18\_PIED

FLAMME SIDAS 18 - VOILE HOUSSE

315167101 CMKPVFLAMSID18\_VOILE

Dimensions : 2,30 m x 60 cm



### NEOPRENE GLUE 1

P99COLLE1 352 51201



### OK NET

SIACOKNET19 818625101

Cleaning spray for analysis and measurement tools, machine pads, scan...



### FOOTBED TEMPLATES

39072011 866 096

Templates for checking shoe or liner size.



### SCISSORS

P99CISTITANIUM 605586101

Strong scissors for cutting footbeds.

## CLOTHES



### SIDAS GILET

SIMKGILSIDAS 379 180



### SIDAS SWEAT SHIRT

SIMKSWEATZIP14 808723000



### SIDAS THIN SWEATER

SIMKSWEAT17 812448000

## DISPLAYS

**FRAME ILLUMINATED DISPLAY**  
CMKPVILLDISPFRAM20 318361101

**SHELVE ILLUMINATED DISPLAY**  
CMKPVILLDISPSHEL20 318363101

**HOLDER ILLUMINATED DISPLAY**  
CMKPVILLDISPHOLD20 318364101

**HOOK ILLUMINATED DISPLAY**  
CMKPVILLDISPHOOK20 318362101

**FIT PROTOCOL ANALYSIS - LIGHT BOX**  
- EN - SIMKFITPROANALYSEN  
- DE - SIMKFITPROANALYSDE  
- FR - SIMKFITPROANALYSFR

**FIT PROTOCOL SUM UP - LIGHT BOX**  
- EN - SIMKFITPROSUMUPEN  
- DE - SIMKFITPROSUMUPDE  
- FR - SIMKFITPROSUMUPFR

**CUSTOM INSOLES - LIGHT BOX**  
- EN - SIMKCUSTOMINSOLEEN  
- FR - SIMKCUSTOMINSOLEFR



### DISPLAY DRYER

Ref. (EMPTY) CSHPACKDRYDISFUL20  
Ref. 319846101  
Ref Empty. CSHMKDRYDISP20  
Ref Empty 319845101

Max capacity: 87 packs  
Cardboard display stand:  
width: 540mm and height: 1400mm  
without the header  
Easy to move around in store  
Two options available:  
- delivered without products  
- delivered assembled with a set of retail ready products  
Included: 50 Cedar Wood dryer bags, 25 Dryflow Mini and 12 Dryflow UV.



### TRACTION DISPLAY

Ref. (EMPTY) CTRMKCARTDISPL16  
Ref. (EMPTY) 309542101  
Ref. Full of product (20 walk demi /40 walk)  
CTRPACTDISPL16  
Ref. Full of product (20 walk demi /40 walk)  
309630101

Paperboard display unit supplied assembled.  
Easy to move around in store.  
Can accommodate 20 Traction 1/2 & 40 Traction, or 60 Traction.  
Two options: Supplied without products.  
Supplied assembled with a set of products ready for sale.



### COLUMN DISPLAY

CMKPVTOURDIS15 301216101

Max. capacity: 120 packs.  
The column display is a rotating display stand featuring:  
- 8 perforated sides  
- 5 castors, 2 of which have brakes  
- 1 platform for attaching a demonstration foot.  
Dimensions: 180 x 55 cm



### MAXI DISPLAY

CMK3DDISPL12 32695201

Max. capacity: 120 packs, 60 on each side.  
Order separately : 2 facing / 2 POP  
Can include a Feet Revelator™.  
Can also be used on one side only.  
Dimensions: 75 x 160 x 60 cm



### MID DISPLAY V2

CMKPVMIID112 32955801

Max. capacity: 120 packs, 60 on each side.  
Order separately : 2 facing / 2 POP  
Can include a Feet Revelator™.  
Can also be used on one side only.  
Dimensions: 75 x 160 x 60 cm



### MINI DISPLAY

CMKPVMIIND115 309027101

Max. capacity: 45 packs, 30 packs on the front and 15 on the back.  
Can also be used on one side only.  
Dimensions: 36 x 128 x 36 cm



# MAPPING



## INSOLES

3D					
	SANISOL 3D	WINTER 3D RENTAL	WINTER 3D MERINO	WINTER 3D PERFORMANCE	NORDIC 3D
3Feet					
	WINTER 3FEET <sup>®</sup> HIGH	WINTER 3FEET <sup>®</sup> MID	WINTER 3FEET <sup>®</sup> LOW		
	3FEET <sup>®</sup> MERINO HIGH	3FEET <sup>®</sup> MERINO MID	3FEET <sup>®</sup> MERINO LOW		
FLASHFIT					
	WINTER +	WINTER + SLIM	COMFORT + MERINO		
C   Custom					
	WINTER CUSTOM COMFORT	WINTER CUSTOM RACE MERINO	WINTER CUSTOM SKI	WINTER CUSTOM PRO	
	CUSTOM XC CLASSIC	CUSTOM XC SKATING	CUSTOM COMFORT MERINO	WINTER CUSTOM PRO HEAT READY	
HEAT					
	3D POWER HEAT	FLAT POWER HEAT	POWER HEAT ELEMENTS & COVERS	HEAT READY PACK 10	
MODULO					

## SOCKS

SOCKS SKI COMFORT	SOCKS SKI MERINO	SOCKS SKI PROTECT	SOCKS SKI ULTRAFIT	SOCKS SKI HEAT

## FOOT PRODUCTS

SHIN PROTECTOR	ANKLE PROTECTOR	FOOT PROTECTOR SHEET 2 mm	GEL TOE WRAP	GEL TOE CAP	GEL PLANTAR PROTECTORS

## BOOTWEAR

THERMO INNERBOOTS						
	CENTRAL REMOVABLE TONGUE (CRT SLIM)	CENTRAL REMOVABLE TONGUE (CRT)	CENTRAL HIGH V3	CENTRAL WOMAN		
PU INNERBOOTS						
	PU CLASSIC RACE	PU CLASSIC COMFORT	PU TRANSFOAM FLEX	PU CLASSIC FLEX W		
PU LANGUETTE						
	TONGUE HEAT READY	READY-TO-FIT TONGUE SLIM	READY-TO-FIT TONGUE V2	PU FOAM TONGUE		

## BOOT & SHOE ACCESSORIES

TRACTIONS						
	WALK TRACTION	WALK TRACTION	SKIBOOTSTRACTION			
BOOSTER						
	POWER STRAP MEN					
BOOT BAGS						
	BOOT BAG WOMEN	BOOT BAG BLACK	NYLON SHOE BAG	BOOT BAG BLUE	BOOT BAG MOUNTAIN	LIGHT SHOE BAG POCKET BAG
DRYING & HEATING						
	DRYWARMER NEO USB	DRYWARMER PRO USB	DRYFLOW UV	DRYFLOW MINI		



# MEASURING THE FOOT

## SIZES

A size is a series of measurements, expressed in points, that characterise a foot, last or shoe. There are different size systems, each with its own history and logic: The Paris Point (EUR), the American Point (US) and the English Point (UK).

The Mondopoint (MP) system, resulting from work carried out by more than 18 countries and governed by international standard ISO 9407, has been created to harmonise the scales.

## STEP 1

Measurement of the length and width of the foot

**1** Analysis of the foot length

**2** Analysis of the foot width

$L = H / \cos(\varphi)$

$\varphi = 18^\circ$

Foot Sizer

## STEP 2

Pressure analysis

Analysis of the foot pressure

**1** **2** **3**

Feet Revelator™

- Two pressure points
- Anatomical pressure
- Uniform pressure

## STEP 3

Analysis of volume and shape

Analysis of the volume and shape of the foot

Podoscope

- High-arched foot
- Medium-arched foot
- Low-arched foot

# SIZE & FOAM CHART

Sizes	Insoles	Socks	Thermo Innerboots	PU Innerboots	Foam set colors (tongue)
MP					
20					
20 1/2					
21					
21 1/2					
22	XS	XS		C	
22 1/2	MP 22 - 23 EUR 35 - 36 UK 2 - 3 US 3 - 4	MP 22 - 23 EUR 35 - 36 UK 2 - 3 US 3 - 4			
23			D	D	
23 1/2	S	S			
24	MP 23 1/2 - 24 1/2 EUR 37 - 38 UK 4 - 5 US 5 - 6	MP 23 1/2 - 24 1/2 EUR 37 - 38 UK 4 - 5 US 5 - 6		E	
24 1/2					
25		S / M			
25 1/2	M	MP 25 - 26 1/2 EUR 39 - 41 UK 6 - 7 US 7 - 8			
26			M / L		
26 1/2			MP 26 - 26.5 EUR 40 - 41 UK 6.5-7 US 7.5-8	G	
27	L	L		H	
27 1/2	MP 27 - 28 EUR 42 - 43 UK 8 - 9 US 9 - 10	MP 27 - 28 EUR 42 - 43 UK 8 - 9 US 9 - 10			
28				I	
28 1/2	XL				
29	MP 28 1/2 - 29 1/2 EUR 44 - 45 UK 10 - 11 US 11 - 12			J	
29 1/2		XL			
30		MP 28.5-30 EUR 44-46 UK 10-12 US 11-13			
30 1/2	XXL			K	
31	MP 29 1/2 - 31 EUR 46 - 48 UK 12 - 13 US 13 - 14				
31 1/2		XXL		L	
		MP 30.5 - 31.5 EUR 47 - 49 UK 12.5 - 13.5 US 13.5 - 14.5			

# DISTRIBUTORS



## AUSTRALIA

Phoenix Leisure Group P/L  
5 Aero Rd,  
Ingleburn NSW 2565  
Ph: 61 2 95526900  
Fax: 61 2 95526922  
info@plg.com.au

## BENELUX

X-Function Benelux B.V  
Jupiterstraat 2  
NL-6468 EV Kerkrade  
The Netherlands  
Ph.: +31-45-2110888  
sales@tck-sports.nl  
www.tck-sports.nl

## CANADA

LANCTÔT LTEE  
5290 Boul. Thimens  
Saint-Laurent, QC  
H4R 2B2  
Ph.: +1 514 7316841  
Fax : +1 514 3424059  
info@rlanctot.com  
www.rlanctot.com

## CHINA

P.R.China  
X-Wing Distribution Ltd  
Danny Jia  
6-21, Commercial Logistics & Storage  
Company Baizhuan, Chaoyang District  
Beijing, 100124  
Ph.: (+86)-15110033522  
jia@xwing.cn

## CZECH REPUBLIC / SLOVAKIA

SVORTO S.R.O.  
Průběžná 30  
100 00 PRAHA 10  
Ph.: +42 0241740341  
sidas@svorto.cz  
www.sidas.cz

## DENMARK

PIST TRADING  
Blokken 67  
3460 BIRKERØD  
Ph.: +45 28448240  
pn@sidas.dk  
www.sidas.dk

## FINLAND

SKÖNÄRI OY  
Höyläämötie 12  
00380 HELSINKI  
Ph.: +358 400-70.68.27  
snyffe@gmail.com

## FRANCE / ANDORRE

SIDAS Sport France  
18, rue Léon Béridot  
BP 353 - ZAC Champfeuillet  
38509 VOIRON CEDEX - France  
Ph.: +33 (0)4 76 67 07 24/ 11/ 14  
Fax: +33 (0)4 76 67 03 03  
sidassportfrance@sidas.com

## GERMANY/AUSTRIA

STC DISTRIBUTION GMBH  
Triesterstrasse 179  
8073 Feldkirchen bei Graz  
AUSTRIA  
Ph Germany : 0800 180 2373  
Ph. Austria: +43 316 243 793 0  
Fax: +43 316 243 793-10  
sales@stc-sport.com

## HONG KONG

Biomechanics Limited  
BIOME  
1305-6, 13/F Asia Standard Tower,  
59-65 Queen Road Central,  
Hong Kong  
Tel: +852 3702 0853  
contact@biomeasia.com  
www.biomeasia.com

## HUNGARY

FLEX 92 Kft.  
Csata u. 8.  
2040 Budaörs  
Ph/Fax: +36 23 414 699  
Mobile phone: +36309402253  
flex92kft@t-online.hu

## ITALIA

VICH ITALIA S.R.L  
Via Borgo Palazzo 274  
24125 BERGAMO  
Ph.:+39 035 4596078  
info@vichitalia.com  
www.vichitalia.com

## JAPAN

SIDAS JAPAN  
Kannai Wise 7F  
2-9-1 Furocho Naka-ku  
Yokohama  
231-0032 Japan  
Ph.: +81 045 263 9559  
Fax: +81 045 263 9558  
info@sidas.co.jp  
www.sidas.co.jp

## NEW ZEALAND

BRANDEX LTD  
204 Cumnor Terrace  
WOOLSTON 8241,  
CHRISTCHURCH  
Ph.: +64 3 3812190  
Fax: +64 3 3812191  
hq@brandex.co.nz

## UNITED STATES OF AMERICA

Sidas Technologies, NA Inc.  
5628 Airport Way S. Suite 280  
Seattle, WA 98108  
PH: +1604732 9144  
FAX: +1604270 1906  
info-us@sidas.com

## NORWAY

RAMO AS  
Hvamsvingen 4  
2013 Skjetten.  
Norway  
Ph:+47 67910200  
Kundeservice@ramo.no

## POLAND

WINDSPORT Sp. Jaw.  
ul. Zakopianska 56a  
30-418 Kraków  
tel. +48 12 267 79 60  
sidas@sidas.pl  
www.sidas.pl

## RUSSIA

SIDAS RUSSIA  
105005 Moscow  
Baumanskaya str, 7  
PH.: +7 (495) 729 2406  
info@sidas-russia.ru  
www.sidas-russia.ru

## SINGAPORE

Outdoor Venture Pte Ltd  
17 Kaki Bukit Crescent  
#04-02, Kaki Bukit Techpark 1  
Singapore 416248  
Ph: +65 6846 1227  
info@outdoor-venture.com  
www.outdoor-venture.com

## SLOVENIA CROATIA / BIH

MATIAS 2 D.O.O.  
Špelina ulica 1  
2000 MARIBOR  
Ph.: +386 (0)2 426 0126  
FAX: +386 (0)2 461 2741  
info@matias2.si  
www.matias2.si

## SOUTH KOREA

PJTUNE CO.LTD  
135-815  
9F Mediacerter 58-9  
Nonhyeon 1-dong  
Gangnamgu  
SEOUL  
Ph.: +82 22209 0250  
Fax: +82 22209 0260  
pjhjia@hotmail.com  
www.pjtune.com

## SPAIN / PORTUGAL

SIDAS SPAIN SL  
Vallirana 30 bajos  
08006 BARCELONA  
PH.: +34 932 183 722  
sidas@sidas.net  
www.sidas.com

## SWEDEN

SCANTRADE SCANDINAVIA AB  
DALSTIGEN 6  
SE-523 45 ULRICEHAMN  
SWEDEN  
Ph +46313350150  
www.scantrade.se  
info@scantrade.se

## SWITZERLAND

SIDAS SUISSE SARL  
C/o D4 Platz 3  
6039 ROOT LÄNGENBOLD  
Ph.: 0800 123 808  
Fax: +43 316 243 793-10  
suisse@sidas.com

## TAIWAN

STARLIKE INTERNATIONAL LTD  
8F, No.47, LANE 3 Jihu road,  
Neihu District  
11492 TAIPEI CITY  
TAIWAN  
Ph: +886 2 8751-5235

## THAILAND

JOLI SNOB Co., Ltd.  
15 Pattanavet 11, Sukhumvit 71,  
Klongtun-nua,  
Wattana, Bangkok,  
Thailand 10110  
Tel: (+66)2-711-7134 to 6  
info@jolisnob.ne

## UK

SIDAS UK LTD  
Bridge House,  
1 Bridge Street,  
Kendal, LA9 7DD,  
Tel + 44 15 39 72 58 17  
FAX + 44 15 39 72 96 61  
info@sidas.co.uk  
www.sidas.co.uk

## IRELAND

SIDAS UK LTD  
Des McCarley  
Tel + 44 77 40 95 87 07  
Fax + 44 15 39 72 96 61  
Des.McCarley@sidas.co.uk  
www.sidas.co.uk

